

vtech®

CareLine™

Complete user's manual

www.vtechphones.com



Models:
SN1196/SN1197/SN6196/
SN6196-2/SN6197/SN6197-2



DECT 6.0

Congratulations

on purchasing your new VTech product. Before using this telephone, please read **Important safety instructions** on pages 141-142 of this manual.

This manual has all the feature operations and troubleshooting necessary to install and operate your new VTech telephone. Please review this manual thoroughly to ensure proper installation and operation of this innovative and feature rich VTech product. For support, shopping, and everything new at VTech, visit our website at **www.vtechphones.com**. In Canada, visit **www.vtechcanada.com**.



The ENERGY STAR® program (www.energystar.gov) recognizes and encourages the use of products that save energy and help protect our environment. We are proud to mark this product with the ENERGY STAR® label indicating it meets the latest energy efficiency guidelines.



Telephones identified with this logo have reduced noise and interference when used with most T-coil equipped hearing aids and cochlear implants. The TIA-1083 Compliant Logo is a trademark of the Telecommunications Industry Association. Used under license.

Register online to get an additional 3-month warranty!
Visit www.vtechphones.com.



Registration

Register your product online for enhanced warranty support.



Product news

Learn about the latest VTech products.

Parts checklist

SN1196/SN1197

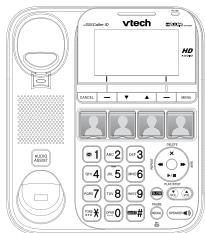

Telephone base



Corded handset



Pendant with lanyard



Pendant charger with
charger adapter



Pendant belt clip

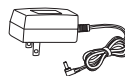

Telephone base
power adapter



Telephone line cord



Quick start guide

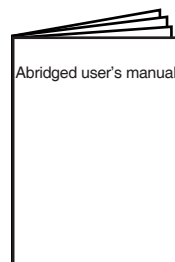

Abridged user's manual

Parts checklist

SN6196/SN6196-2/SN6197/SN6197-2

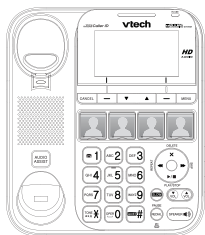

Telephone base



Corded handset



Pendant with lanyard



Cordless handset

(1 for SN6196/SN6197)
(2 for SN6196-2/SN6197-2)

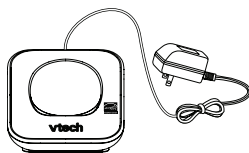

Handset charger with
charger adapter

(1 for SN6196/SN6197)
(2 for SN6196-2/SN6197-2)



Pendant charger with
charger adapter



Battery compartment cover

(1 for SN6196/SN6197)
(2 for SN6196-2/SN6197-2)



Battery

(1 for SN6196/SN6197)
(2 for SN6196-2/SN6197-2)



Pendant belt clip

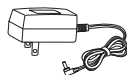

Telephone base
power adapter



Telephone
line cord

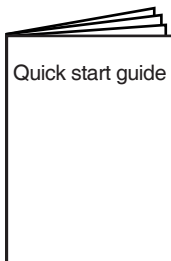

Quick start guide

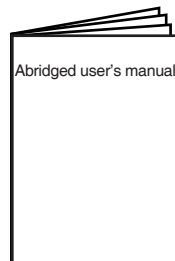

Abridged user's manual

Table of contents

Getting started	1	Set date and time	35
Telephone base installation.....	1	Voice Announce® caller ID.....	36
Telephone base backup battery installation	2	LCD language.....	38
Handset battery installation	3	Talking digit	39
Handset charger installation	4	Voicemail number.....	40
Pendant charger installation.....	5	Clear voicemail indicators.....	42
Pendant attachment	6	Rename base/handset	43
Handset battery charging	7	Key tone	43
Pendant battery charging	8	Use caller ID to automatically set date and time	44
Installation options.....	9	Home area code.....	45
Tabletop to wall mount installation	9	Dial mode	46
Wall mount to tabletop installation	11	Quiet mode	47
Are you a new cable or VoIP subscriber?	13	Voice command.....	48
Did you subscribe to voicemail service from your telephone service provider?.....	14	Happy message.....	49
Expand your telephone system.....	15	Telephone operation	50
Add and register a handset	15	Make a call	50
Add and register a pendant	16	Redial a call.....	50
Deregister all devices	18	Answer a call	51
Telephone base layout	19	End a call.....	51
Pendant layout.....	23	Speakerphone	51
Handset layout.....	24	Equalizer.....	52
Telephone settings	27	Audio Assist®	53
Photo speed dial.....	27	Volume control.....	54
Using the menu	32	Mute.....	54
Ringer volume	33	Call waiting	55
Ringer tone	34	Temporary ringer silencing	55
		Redial	56
		Temporary tone dialing.....	57
		Check voicemail	58
		Web address	58
		Chain dialing.....	59

Table of contents

Transfer a call.....	60	Review the caller ID log.....	87
Find handset/pendant.....	62	View dialing options.....	88
Multiple handset use.....	63	Dial a caller ID log entry	89
Join a call in progress.....	63	Save a caller ID log entry to the phonebook	90
Intercom.....	64	Delete caller ID log entries	91
Answer an incoming call during an intercom call.....	68	Caller ID log screen messages.....	91
Transfer a call during an intercom call.....	69	Reminder.....	92
Phonebook.....	73	About the reminder.....	92
About the phonebook	73	Add a reminder	92
Add a phonebook entry	74	Review reminders.....	96
Review phonebook entries	76	Add and review reminders remotely	97
Alphabetical search	77	Reminder on/off	97
Dial a phonebook entry.....	77	Answering system	
Edit a phonebook entry.....	78	settings	98
Delete a phonebook entry	79	Answering system	98
Photo speed dial.....	80	Announcement	99
Store a photo speed dial entry...	80	Record your own announcement	99
Edit a photo speed dial entry ...	82	Play your announcement.....	101
Delete a photo speed dial entry	83	Answer on/off.....	102
Dial a photo speed dial number.....	83	Call screening.....	104
Caller ID.....	84	Number of rings.....	105
About the caller ID log	84	Remote access code	106
Information about caller ID with call waiting	84	Message alert tone	107
Caller ID log.....	85	Message recording time	108
Missed call indicator	86	Answering system	
Memory match.....	86	operation.....	109
		Answering system and voicemail.....	109

Table of contents

Using the answering system and voicemail together.....	110	Energy-saving charging mode	144
Message capacity.....	110	Maintenance	144
New message indication.....	111	About cordless telephones	145
Call screening.....	111	The RBRC® seal	146
Call intercept.....	112	Limited warranty	147
Temporarily turn off the message alert tone	112	FCC, ACTA and IC regulations	149
Message playback.....	113	Technical specifications.....	152
Delete all old messages	115	Index	153
Record, play and delete memos	116		
Remote access.....	117		
Voice command	119		
About voice command.....	119		
Use voice command	119		
Appendix	122		
Display screen messages.....	122		
Handset, telephone base and pendant indicators.....	126		
Handset battery	129		
Pendant battery	130		
Troubleshooting.....	131		
Important safety instructions...	141		
Precautions for users of implanted cardiac pacemakers	143		
Operating range.....	143		
ECO mode.....	143		

Getting started

Telephone base installation

Install the telephone base as shown below.

Make sure that the electrical outlet is not controlled by a wall switch.

If you subscribe to digital subscriber line (DSL) high-speed Internet service through your telephone line, you must install a DSL filter between the telephone line cord and the telephone wall jack. The filter prevents noise and caller ID problems caused by DSL interference. Contact your DSL service provider for more information about DSL filters.

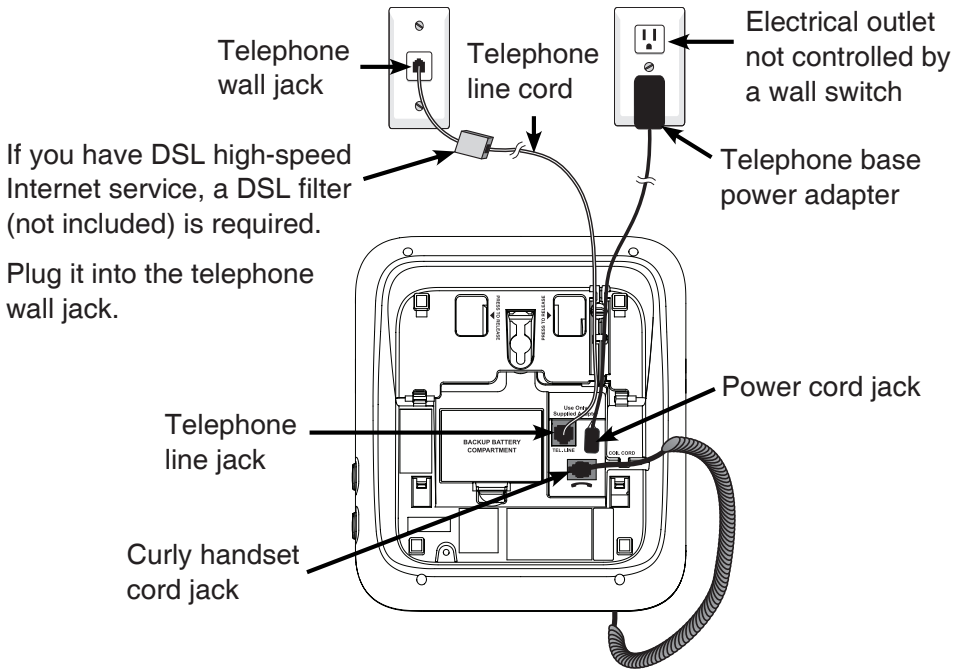

IMPORTANT:

Check for a dial tone by pressing . If you hear a dial tone, the installation is successful.

If you do not hear a dial tone:

- Make sure the installation is properly done.
- It may be a wiring problem. If you have changed your telephone service to digital service from a cable company or a VoIP service provider, the telephone line may need to be rewired to allow all existing telephone jacks to work. Contact your cable/VoIP service provider for more information.

Getting started

Telephone base backup battery installation

This telephone provides minimal functionality during a power outage when there is no battery installed. When there is no power supply to the telephone base, many telephone features are not functional. The telephone uses power from the telephone line to enable you to make and answer calls using only the corded handset and dialing keys. However, when another telephone on the same line is being used simultaneously, there might not be sufficient power to use your telephone in the event of a power failure.

Install three AAA batteries (not provided) so that your telephone can still operate in the event of a power failure.

1. Press the large tab on the backup battery compartment cover. Then pull to open.

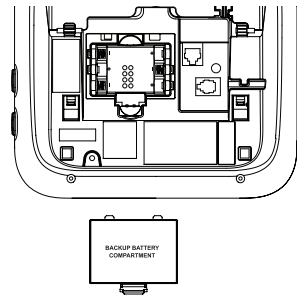
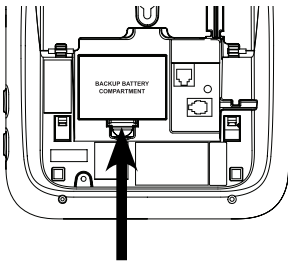

2. Place three AAA batteries into the compartment, matching the polarity engravings.

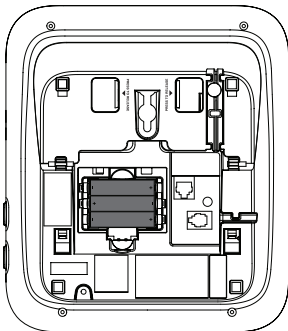

3. Replace the backup battery compartment cover. Push the large tab until it locks securely.

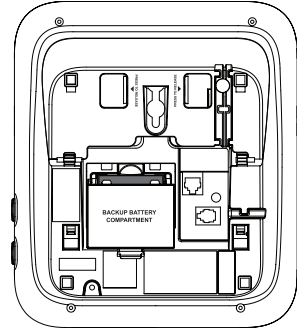

Getting started

Handset battery installation

Install the battery as shown below.

1. Plug the battery connector securely into the socket inside the handset battery compartment, matching the orientation of the engraved label.
2. Place the battery with the label **THIS SIDE UP** facing up and the wires inside the battery compartment.

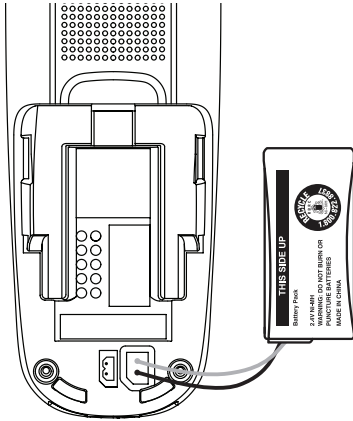

3. Align the cover flat against the battery compartment, then slide it towards the center of the handset until it clicks into place.

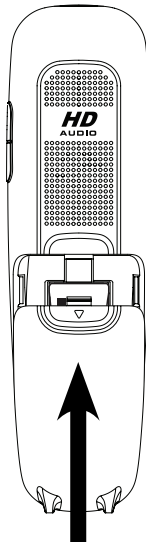

Getting started

Handset charger installation

1. Install the charger as below.

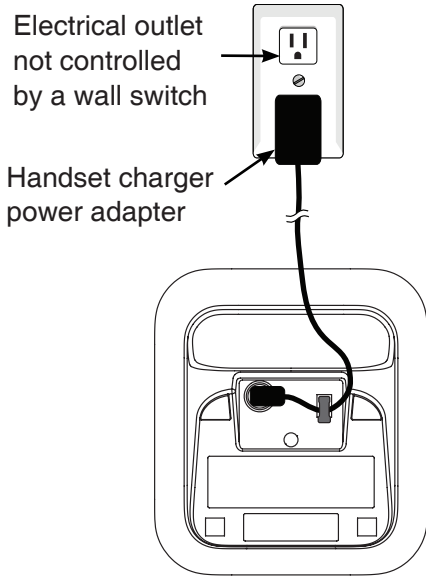

2. Place the handset in the handset charger to charge.

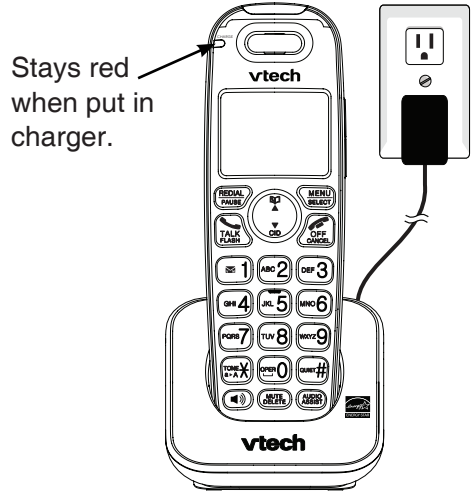

note

- If the handset will not be used for a long time, disconnect and remove the battery to prevent possible leakage.
- To purchase replacement batteries, visit our website at www.vtechphones.com or call 1 (800) 595-9511. In Canada, go to www.vtechcanada.com or dial 1 (800) 267-7377.

Getting started

Pendant charger installation

1. Install the pendant charger as shown below.

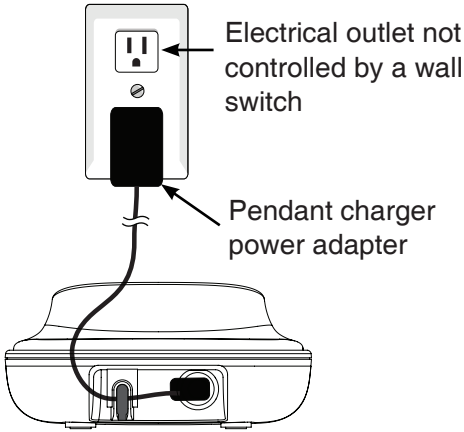

2. Switch **ON** the pendant.

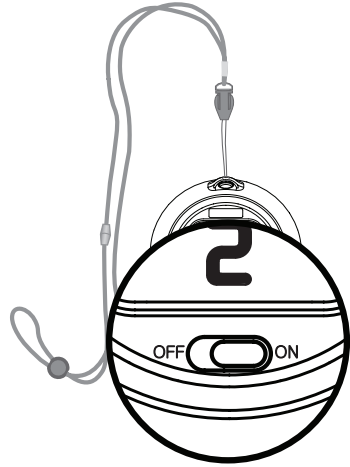

3. Place the pendant in the pendant charger to charge.

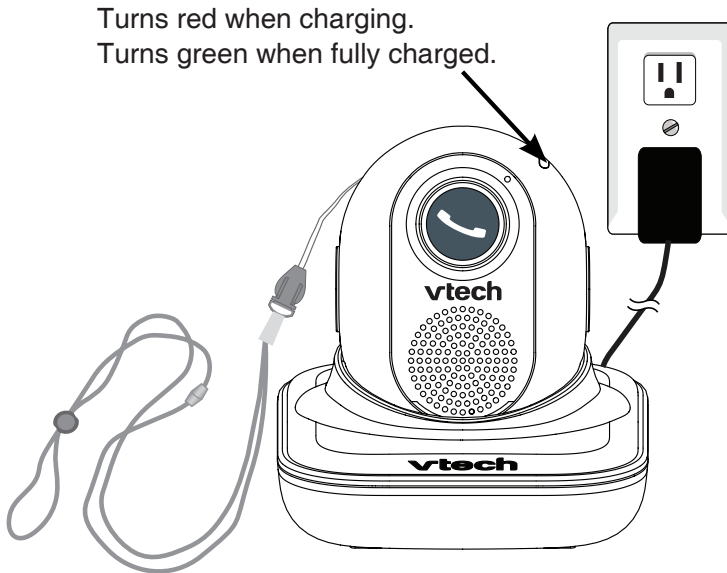

Getting started

Pendant attachment

Pendant lanyard:

The pendant lanyard is already attached to the pendant. You can adjust the length of the lanyard for comfortable wearing, or remove the necklace when necessary.

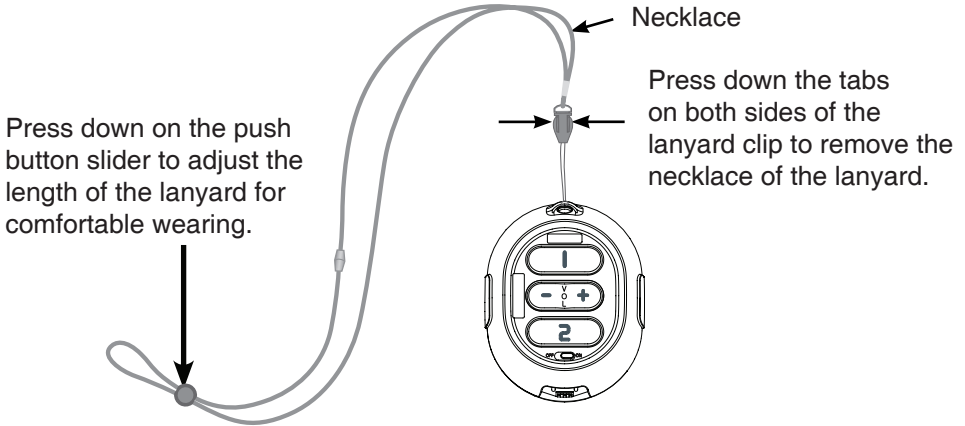

Pendant belt clip:

Remove the necklace of the pendant lanyard or the whole pendant lanyard before you use the pendant belt clip.

Push the pendant into the belt clip until it clicks into place.





Getting started

Handset battery charging

Once you have installed the battery, the handset indicates the battery status (see the table below). If necessary, place the handset in the handset charger to charge the battery. For best performance, keep the handset in the handset charger when not in use. The battery is fully charged after 11 hours of continuous charging.

If the screen is blank or displays **Place in charger**, you need to charge the handset battery without interruption for at least 30 minutes to give the handset enough charge to use for a short time. When the battery is low, the handset displays **Low battery** along with a flashing  icon. If you are on a call in low battery mode, the handset plays short beeps to alert you.

The following table summarizes the battery charge indicators and actions to take.

Battery indicators	Battery status	Action
The screen is blank, or displays Place in charger and  flashes.	The battery has no or very little charge. The handset cannot be used.	Charge without interruption (about 30 minutes).
The screen displays Low battery and  flashes.	The battery has enough charge to be used for a short time.	Charge without interruption (about 30 minutes).
The screen displays HANDSET X .	The battery is charged.	To keep the battery charged, place it in the handset charger when not in use.

note

If you place the handset in the handset charger without installing a battery, the handset displays **No battery**.

After you install your telephone or power returns following a power outage, the telephone base and handset will prompt you to set the date and time. For instructions, see **Set date and time** on page 35. To skip setting, press **CANCEL**.



Getting started

Pendant battery charging

The pendant status light indicates the battery status (see the table below). If necessary, place the pendant in the pendant charger to charge the battery. For best performance, keep the pendant in the pendant charger when not in use. The battery is fully charged after 3 hours of continuous charging.

If the pendant status light flashes red and you hear “*Low battery*”, you need to charge the pendant without interruption to give it enough charge to use for a short time. When the battery is low, the pendant status light flashes red. If you are on a call in low battery mode, the pendant plays short beeps to alert you.

The following table summarizes the battery charge indicators and actions to take.

Battery indicators	Battery status	Action
The pendant status light flashes red. You hear “ <i>Low battery</i> ” when there is only 30 minutes talk time left. You hear an alert tone every one minute.	The battery has very little charge.	Charge without interruption.
The pendant status light is solid red.	The battery has enough charge to be used for a short time.	Charge without interruption.

Getting started

Installation options

Your telephone base is ready for tabletop use. If you want to mount your telephone on a wall, swivel the wall mount bracket down to connect with a standard dual-stud telephone wall mounting plate. If you do not have this mounting plate, you can purchase one from many hardware or consumer electronics retailers. You may need a professional to install the mounting plate.

Tabletop to wall mount installation

1. Unplug the power adapter and telephone line from the wall outlets.
2. Squeeze the tabs on the wall mount bracket as the arrows indicated below.

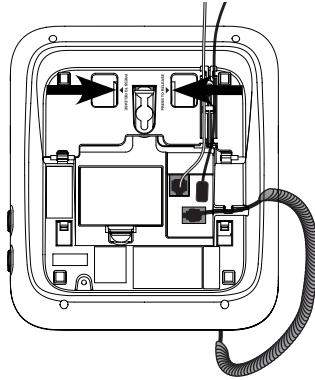

3. Swivel the wall mount bracket down. Press the wall mount bracket onto the telephone base until it clicks into place.

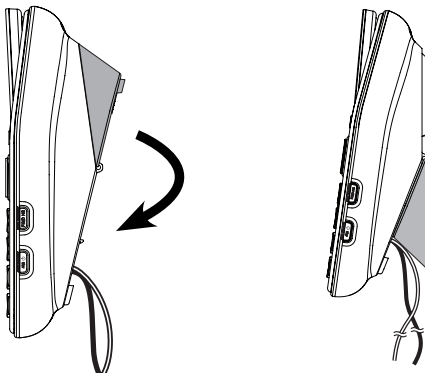

Tabletop position

Wall mount position

Getting started

Tabletop to wall mount installation

- Put the corded handset aside. Press down the switch hook and remove the handset tab from the slot. Rotate the handset tab by a half turn. Press down the switch hook and then replace the handset tab to its slot.

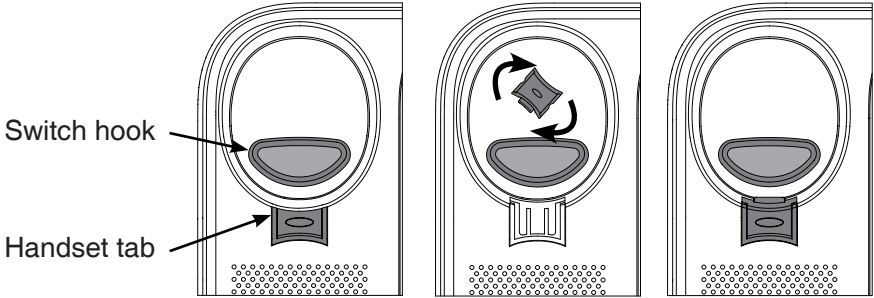

- Plug the power adapter and telephone line into the wall outlets. Align the holes on the wall mount bracket with the standard wall mounting plate and slide the telephone down until it locks securely. Bundle the telephone line cord and power adapter cord neatly with twist ties. Put the corded handset back on the telephone base.

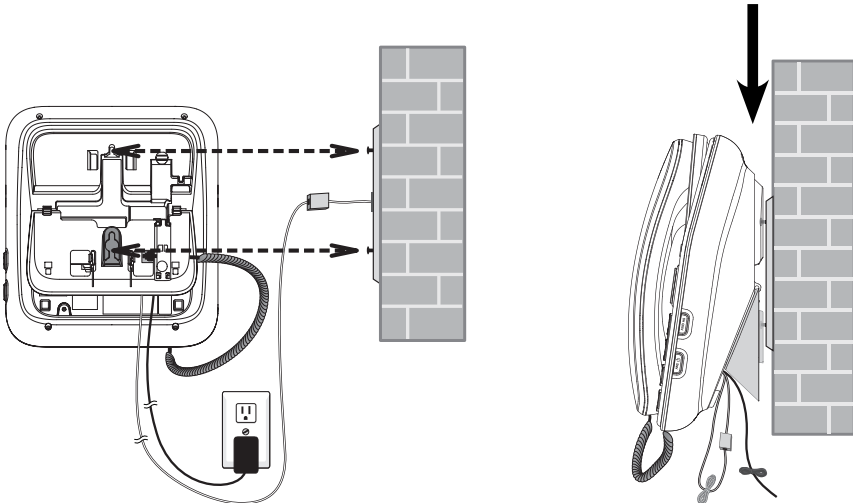

Getting started

Wall mount to tabletop installation

1. If necessary, untie the bundled telephone line cord and power adapter cord. Unplug the power adapter and telephone line cord from the wall outlets.
2. Remove the telephone base from the wall.

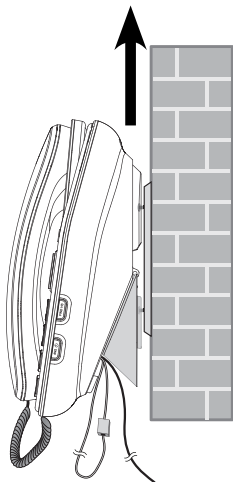

3. Pull the wall mount bracket to release it from the telephone base. Swivel it upwards and then press onto the telephone base until it clicks into place.

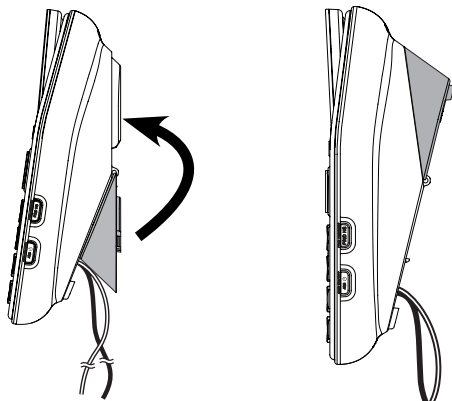

Wall mount position

Tabletop position

Getting started

Wall mount to tabletop installation

4. Press down on the switch hook and slide the handset tab upwards to remove it from the slot. Rotate the handset tab by a half turn. Press down the switch hook and then replace the handset tab to its slot.

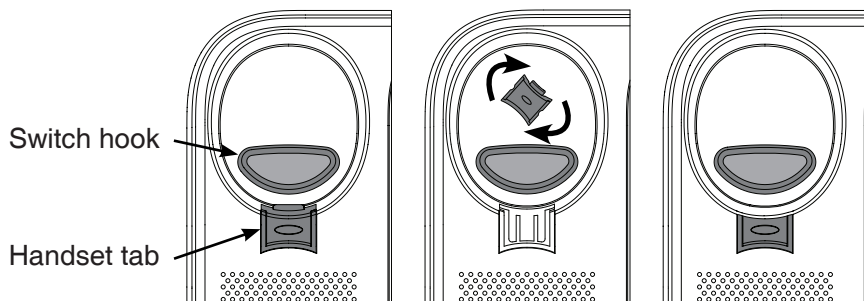

5. Plug the power adapter and telephone line cord into the wall outlets. Put the corded handset back on the telephone base.

Getting started

Are you a new cable or VoIP subscriber?

If your answer is **yes**, the existing telephone jacks in your home may no longer work. Your cable/VoIP service provider uses a different connection, separate from your old traditional telephone service, to connect the modem/router/terminal adapter installed in your home.

To allow all existing telephone jacks to work, contact your telephone service provider for solutions, such as rewiring services (fees may apply).

If your answer is **no**, your existing telephone jacks will continue to work as normal.

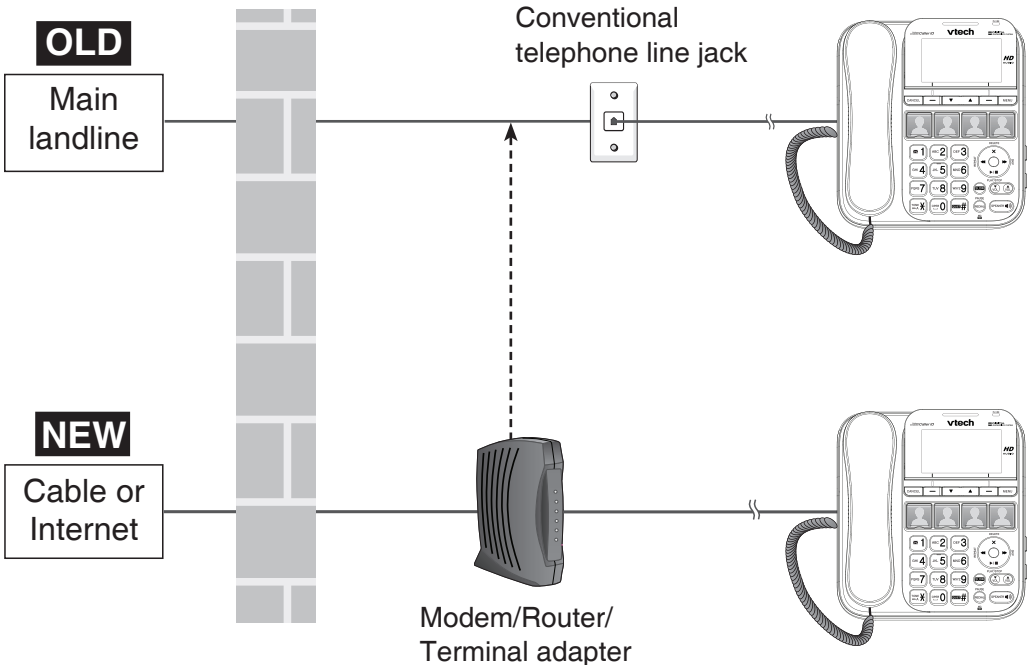

Getting started

Did you subscribe to voicemail service from your telephone service provider?

Your telephone has a built-in answering system and supports voicemail feature offered by your telephone service provider (subscription is required, and fees may apply). Refer to **Answering system and voicemail** on page 109 for more details.

To use the built-in answering system:

You may see this online **Complete user's manual** on how to record your outgoing announcement, retrieve messages and other related operations. You may also see the **Abridged user's manual** provided in the product package for abbreviated instructions.

To use the voicemail:

To retrieve your voicemail messages, you typically dial an access number provided by your telephone service provider, and then enter a security code. Contact your telephone service provider for instructions on how to configure the voicemail settings and listen to messages.

Getting started

Expand your telephone system

You can expand your telephone system by adding new handsets (**SN6107**, purchased separately) and/or new portable pendants (**SN6166/SN6167**, purchased separately). The telephone base can support up to 12 devices. Each device must be registered to the telephone base before use.

The handsets and pendant provided within the product package are already registered. Additional handsets are assigned numbers in the sequential order.

Add and register a handset

When first purchased, each accessory handset shows **To register HS, see manual**. The new handset should be charged without interruption for at least 30 minutes before registering it to the telephone base.

Make sure the handset is out of the handset charger and is put near the telephone base. Make sure the handset shows **To register HS, see manual** before you begin registration.

To register a handset:

1. Press **MENU** on the telephone base when it is not in use.
2. Press **▼** or **▲** to scroll to **Settings**, then press **SELECT**.
3. Press **▼** or **▲** to scroll to **Registration**, then press **SELECT**. The telephone base shows **Registering... Please wait**.
4. Press **QUIET#** on the cordless handset. The handset shows **Registering... Please wait**. Then **HANDSET X Registered** appears on the cordless handset and the telephone base, and both devices beep. The handset is now registered with the telephone base. It takes up to 60 seconds to complete registration.



If registration fails, the telephone base displays **Registration failed**. Start again from Step 1 above.

Getting started

Add and register a handset

note

- You cannot register a handset if any other system device is in use.
- The telephone base shows **Registration slots are full** when you try to register more than 12 devices to it.
- If you have not set the date and time for the telephone system, the handset will prompt you to set the date and time after it is registered to the base. To skip setting, press **CANCEL**.

Add and register a pendant

When first purchased, charge the pendant in the pendant charger. You hear three beeps every 10 seconds when the pendant is not registered. The new pendant should be charged without interruption for at least 30 minutes before registering it to the telephone base.

Make sure the pendant is out of the pendant charger and turned on.

To register a pendant:

1. Press **MENU** on the telephone base when it is not in use.
2. Press **▼** or **▲** to scroll to **Settings**, then press **SELECT**.
3. Press **▼** or **▲** to scroll to **Registration**, then press **SELECT**. The telephone base shows **Registering... Please wait**.
4. Put the pendant in the pendant charger. The pendant status light flashes red and green to indicate the registration is in progress. Then **PENDANT Registered** appears on the telephone base, and both devices beep. The pendant is now registered with the telephone base. It takes up to 60 seconds to complete registration.

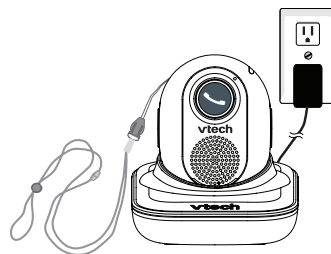
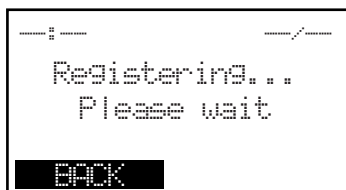

Getting started

Add and register a pendant

5. If you have already set the photo speed dial keys **1** and **2**, the telephone base displays **Copied Photo Speed Dial 1 and Pendant Memory 1**. Press **NEXT**, then the telephone base displays **Copied Photo Speed Dial 2 and Pendant Memory 2**. Then press **OK**.

-OR-

If you have not set the photo speed dial keys **1** and **2**, see **To set photo speed dial** from page 27 to page 29 to set them.

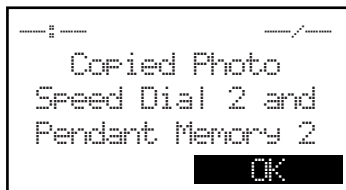
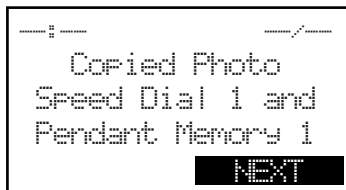

If registration fails, the telephone base displays **Registration failed**. Start again from Step 1 above.

note

- If the pendant is not registered and you press **VOICE** key, you will hear “*Not registered.*”
- You cannot register a pendant if any other system devices is in use.
- The telephone base shows **Registration slots are full** when you try to register more than 12 devices to it.

Getting started

Deregister all devices

If you want to replace a device, or reassign the designated handset number of a registered handset, you must deregister all devices that are registered to the telephone base. Then register each device individually.

To make deregistration easier, read all of the instructions on this page before you begin.

To deregister all devices:

1. Press and hold **FIND HS** at the side of the telephone base for about 10 seconds until the **IN USE** light starts to flash and the telephone base shows **Registering... Please wait** followed by **Deregister all devices?**, then release **FIND HS**.

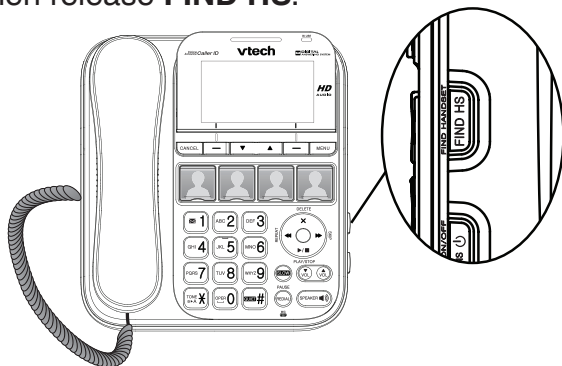

2. Immediately press **YES** or **FIND HS**.
3. All handsets show **To register HS, see manual**. The deregistration process takes about 10 seconds to complete.

To register the handset(s) or pendant(s) to the telephone base again, follow the registration instructions from page 15 to page 17.

note

- You cannot deregister all devices if any other system device is in use.
- If deregistration fails, you may need to reset the system and try again. To reset, unplug the power and the telephone line cord from the telephone base and remove the backup battery. Then plug the cords back in and install the backup battery again.
- Even if the battery is depleted, you can still deregister all handsets by following the steps above. After the handset is charged for at least 10 minutes, its screen shows **To register HS, see manual**.

Getting started

Telephone base layout

Large tilt display

- Move the top of the display forward or backward to adjust the angle of the screen for maximum visibility.

Visual ringer indicator

- Flashes when the telephone base is ringing.

IN USE light

- On when the phone is in use or the answering system is answering an incoming call.
- On when a device is being registered (pages 15-17).
- Flashes when devices are being deregistered (page 18).
- Flashes when another telephone on the same line is in use.

Softkeys (2)

- Press to select a menu item displayed above the key (page 32).

MENU

- Press to show the menu (page 32).

Photo speed dial keys (1-4)

- Press to set or dial a speed dial number when idle (pages 27-29 or pages 80-81, or page 83).

Dialing keys

- Press to enter numbers or characters.
- Press to answer an incoming call with the speakerphone (page 51).

SPEAKER

- Press to make, answer or end a call (pages 50-51).
- Press to switch between the corded handset and the base speakerphone during a call (page 51).

1

- While reviewing a caller ID log entry, press repeatedly to add or remove 1 in front of the telephone number before dialing or saving it in the phonebook (page 88).
- Press and hold to set or dial your voicemail number (pages 40-41 or page 58).

Getting started

Telephone base layout

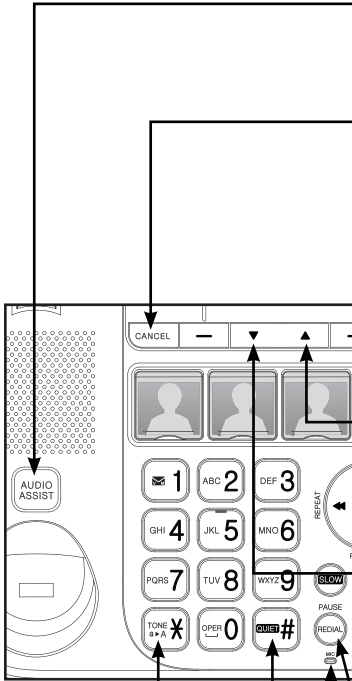

AUDIO ASSIST

- Press to enhance the clarity and loudness of the caller's voice during a call (page 53).

CANCEL

- Press to cancel an operation, or back to the previous menu while in a menu (page 32).
- Press and hold to return to idle mode while in a menu (page 32).
- Press and hold to erase the missed call indicator when idle (page 86).
- Press to silence the base ringer temporarily while the phone is ringing (page 55).



- Press to scroll up while in menus or lists (page 32).
- Press to move the cursor to the right while entering or modifying names or numbers.



- Press to scroll down while in menus or lists (page 32).
- Press to move the cursor to the left while entering or modifying names or numbers.

REDIAL/PAUSE

- Press repeatedly to view the last 10 numbers dialed (page 57).
- Press and hold to insert a dialing pause while dialing or entering numbers.

MIC

- Microphone.

QUIET#

- Press and hold to set and turn on the quiet mode, or turn it off (page 47).
- Press repeatedly to display other dialing options when reviewing a caller ID log entry (page 88).

TONE a▶A

- Press to switch to tone dialing during a call if you have pulse service (page 57).
- Press to switch between upper case and lower case while entering characters.

Getting started

Telephone base layout

◀◀/REPEAT

- Press once to repeat the playing message (page 114).
- Press twice to play the previous message (page 114).
- Press to move the cursor to the left while entering or modifying names or numbers.

X/DELETE

- Press to delete the playing message (page 114), announcement (page 101) or reminder (page 96).
- Press to delete an individual entry while reviewing the redial list (page 57), phonebook (page 79), caller ID log (page 91) or reminder (page 96).
- Press to delete a character or digit while entering names or numbers.

▶▶/SKIP

- Press to skip to the next message during message playback (page 114).
- Press to move the cursor to the right while entering or modifying names or numbers.

▶/■/PLAY/STOP

- Press to start or stop message playback (page 114).
- Flashes when there are new messages or memos in the answering system.

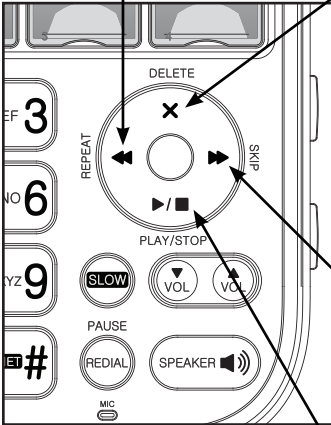

Getting started

Telephone base layout

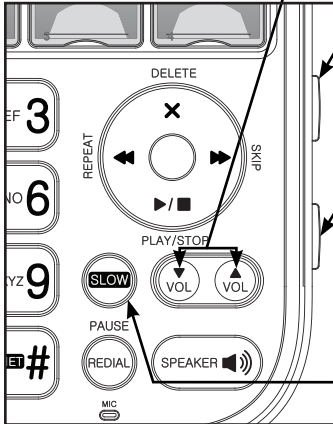

▼VOL and ▲VOL

- Press to adjust the listening volume during a call (page 54), message playback (page 114) or reminder playback (page 96).
- Press to adjust the base ringer volume while idle (page 33).

FIND HS

- Press to page all handsets and pendants when idle (page 62).

ANS

- Press to turn the built-in answering system on or off (page 102).
- On when the answering system is turned on.

SLOW

- Press to slow down the message playback (page 114).

Getting started

Pendant layout

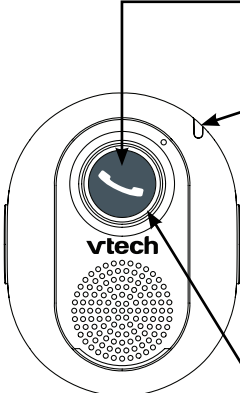

• Press to answer or end a call (page 51).

Pendant status light

- Stays solid red when the pendant is charging.
- Flashes red when the pendant is in low battery.
- Stays solid green when the pendant is fully charged.
- Flashes red and green when the base is paging the pendant.
- Flashes quickly in red and green during pendant registration.
- Flashes orange three times when the pendant is not registered.

Pendant light (ring around ☺)

- On steady when the pendant is in use.
- Flashes quickly when there is an incoming call.
- Flashes twice every three seconds when another telephone system device is in use.

1

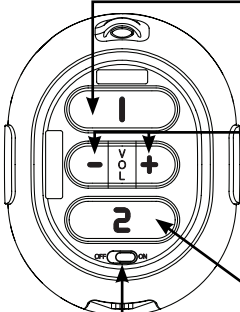

• Press to call photo speed dial 1.

VOL- and VOL+

- Press to adjust the listening volume during a call or message playback (pages 54 and 114 respectively).
- Press to adjust the pendant ringer volume while in idle mode (page 33).

2

- Press to call photo speed dial 2.

ON and OFF switch

- Switch to turn the pendant on or off.

VOICE

- Press to use the voice command feature (page 119).

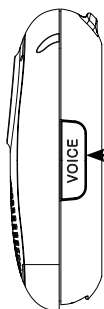

Getting started

Handset layout

CHARGE light

- On when the handset is charging.

Visual ringer indicator

- Flashes when the handset is ringing.

REDIAL/PAUSE

- Press repeatedly to view the last 10 numbers dialed (page 56).
- Press and hold to insert a dialing pause while dialing or entering numbers.



- Press to review the phonebook when idle.
- Press to scroll up while in menus or lists.
- Press to move the cursor to the right while entering names or numbers.



- Press to make or answer a call (page 50 or page 51).
- Press to answer an incoming call when you receive a call waiting alert during a call.



- Press repeatedly to add or remove 1 in front of the telephone number before dialing or saving it in the phonebook while reviewing a caller ID log entry (page 88).
- Press and hold to set or dial your voicemail number (pages 40-41 or page 58).



- Press to switch to tone dialing during a call if you have pulse service (page 57).
- Press to switch between upper case and lower case while entering characters.

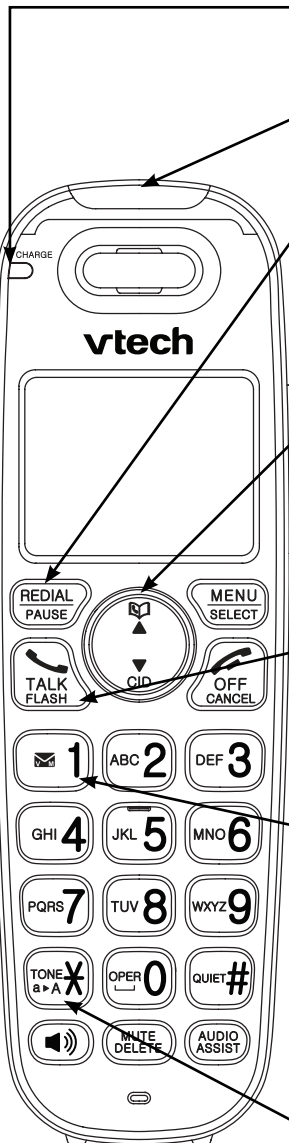

Getting started

Handset layout

CID/▼

- Press to review the caller ID log when idle (page 87).
- Press to scroll down while in menus or lists (page 32).
- Press to move the cursor to the left while entering names or numbers.

MENU/SELECT

- Press to show the menu (page 32).
- Press to select an item or save an entry or setting while in a menu (page 32).

VOL+ and VOL-

- Press to adjust the listening volume during a call (page 54), message playback (page 113) or reminder playback (page 96).
- Press to adjust the handset volume while idle (page 33).

QUIET#

- Press and hold to set and turn on the quiet mode, or turn it off (page 47).
- Press repeatedly to display other dialing options when reviewing a caller ID log entry (page 88).

MUTE/DELETE

- Press to mute the microphone during a call (page 54).
- Press to silence the handset ringer temporarily while the phone is ringing (page 55).
- Press to delete the playing message (page 113), announcement (page 101) or reminder (page 96).
- Press to delete an individual entry while reviewing the redial list (page 56), phonebook (page 79), caller ID log (page 91) or reminder (page 96).
- Press to delete a character or digit while entering names or numbers.

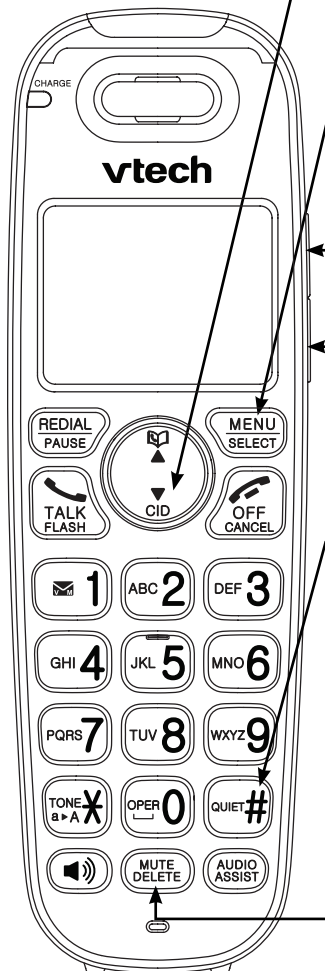

Getting started

Handset layout

OFF/CANCEL

- Press to hang up during a call (page 51).
- Press to cancel an operation, or back up to the previous menu while in a menu (page 32).
- Press and hold to return to idle mode while in a menu (page 32).
- Press to silence the handset ringer temporarily while the phone is ringing (page 55).
- Press and hold to erase the missed call indicator when idle (page 86).

Dialing keys

- Press to enter numbers or characters.
- Press to answer an incoming call (page 51).

AUDIO ASSIST

- Press to enhance the clarity and loudness of the caller's voice during a call (page 53).



- Press to make or answer a call (page 50 or page 51).
- Press to switch between the handset speakerphone and the handset earpiece during a call (page 51).

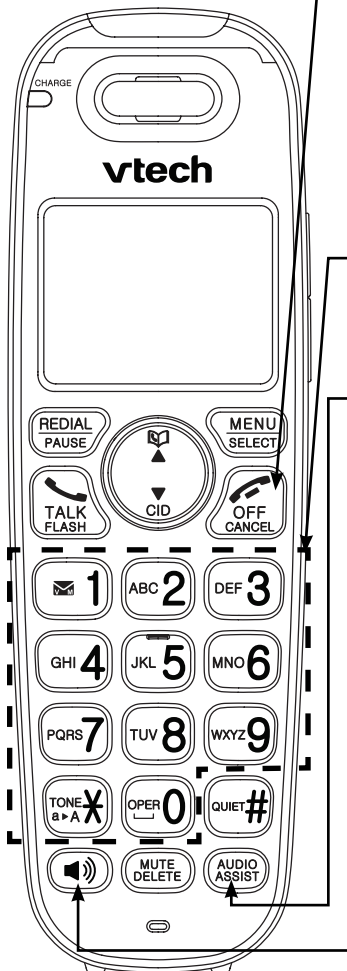

Telephone settings

Photo speed dial

There are four photo speed dial keys on the telephone base. The speed dial keys **1** and **2** on the pendant correspond to the photo speed dial keys **1** and **2** on the telephone base respectively.

We recommend you store two contacts that you may need to call them more often or immediately to photo speed keys **1** and **2**.

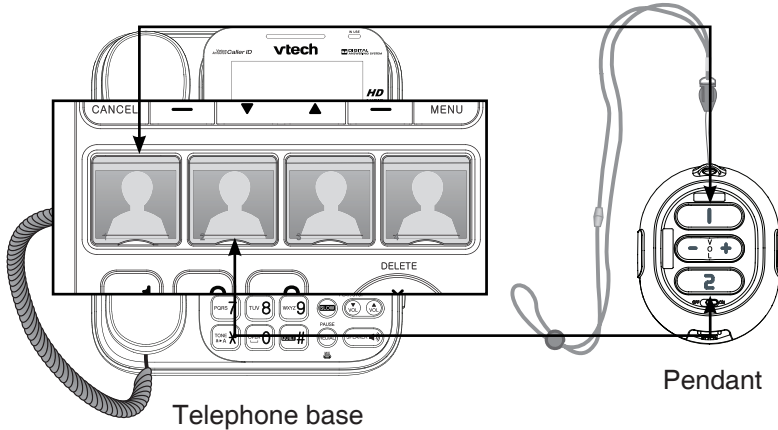

To set speed dial keys 1 and 2 for the pendant:

The telephone prompts you to set photo speed dial **1** and photo speed dial **2** when it is initially powered up.

1. When the telephone base displays **Set Photo Speed Dial 1 and Pendant Memory 1**, press **YES**.
2. When **MEMORY 1 NUMBER** displays, use the dialing keys to enter a number (up to 30 digits):
 - Press **▼** or **▲** to move the cursor to the left or right.
 - Press **X/DELETE** or **BACKSPACE** to erase a digit.
 - Press and hold **X/DELETE** to erase all digits.
 - Press and hold **PAUSE** to enter a dialing pause (a **P** appears).

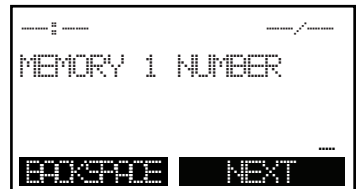
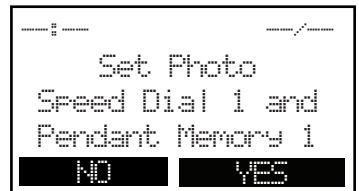

Telephone settings

Photo speed dial

3. Press **NEXT**.
4. When **MEMORY 1 NAME** displays, use the dialing keys to enter a name (up to 15 characters). Each time you press a key, the character on that key appears. Additional key presses produce other characters on that key. Press the key repeatedly until the desired character appears. The first character of each word is capitalized.
 - Press **▼** or **▲** to move the cursor to the left or right.
 - Press **0** to add a space.
 - Press **X/DELETE** or **BACKSPACE** to erase a character.
 - Press and hold X/DELETE to erase all characters.
5. Press **SAVE**. The screen displays **Saved Photo Speed Dial 1 and Pendant Memory 1**. Press **NEXT**.
6. When the telephone base displays **Set Photo Speed Dial 2 and Pendant Memory 2**, press **YES**.
7. When **MEMORY 2 NUMBER** displays, use the dialing keys to enter a number (up to 30 digits):
 - Press **▼** or **▲** to move the cursor to the left or right.
 - Press **X/DELETE** or **BACKSPACE** to erase a digit.
 - Press and hold X/DELETE to erase all digits.
 - Press and hold PAUSE to enter a dialing pause (a **P** appears).
8. Press **NEXT**.
9. When **MEMORY 2 NAME** displays, use the dialing keys to enter a name (up to 15 characters).
 - Press **▼** or **▲** to move the cursor to the left or right.
 - Press **0** to add a space.
 - Press **X/DELETE** or **BACKSPACE** to erase a character.
 - Press and hold X/DELETE to erase all characters.
10. Press **SAVE**. The screen displays **Saved Photo Speed Dial 2 and Pendant Memory 2**. Press **OK**.

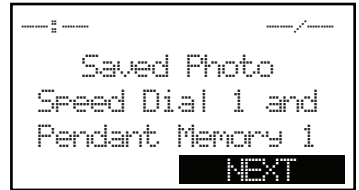
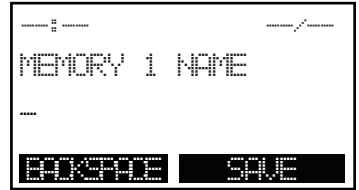

Telephone settings

Photo speed dial

To set and dial a photo speed dial:

1. Press the desired speed dial key.
2. When **MEMORY X NUMBER** displays, use the dialing keys to enter a number (up to 30 digits):
 - Press **▼** or **▲** to move the cursor to the left or right.
 - Press **X/DELETE** or **BACKSPACE** to erase a digit.
 - Press and hold X/DELETE to erase all digits.
 - Press and hold PAUSE to enter a dialing pause (a **P** appears).
3. Press **NEXT**.
4. When **MEMORY X NAME** displays, use the dialing keys to enter a name (up to 15 characters). Each time you press a key, the character on that key appears. Additional key presses produce other characters on that key. Press the key repeatedly until the desired character appears. The first character of each word is capitalized.
 - Press **▼** or **▲** to move the cursor to the left or right.
 - Press **0** to add a space.
 - Press **X/DELETE** or **BACKSPACE** to erase a character.
 - Press and hold X/DELETE to erase all characters.
5. Press **SAVE**. The screen displays **Memory X saved** and you hear a confirmation tone.
6. Press on the photo speed dial key to dial.

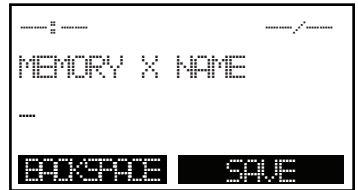
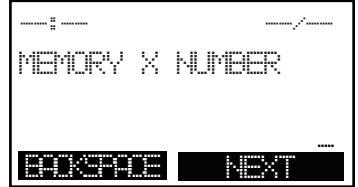

Telephone settings

Photo speed dial

To delete a photo speed dial:

1. Press **MENU** when the telephone base is not in use.
2. Press ▼ or ▲ to scroll to **Photo speed dial**, then press **SELECT**.
3. Press ▼ or ▲ to scroll to the desired location, then press **X/DELETE**.
4. When the screen displays **Clear Memory X?**, press **YES** to confirm. Then the screen displays **Memory X cleared**.

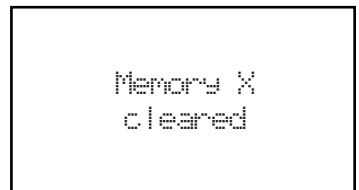

Telephone settings

Photo speed dial

To add a photo:

You can add a desired photo into the photo speed dial compartment, or write the contact name on the photo speed dial card.

1. Flip open the photo speed dial compartment cover and take out the photo speed dial card.

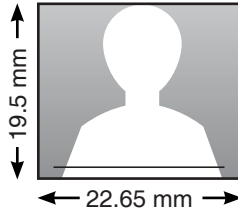

2. Use the photo speed dial card as a tool to crop your desired photo.
3. Put the cropped photo into the photo speed dial compartment. Then flip down the photo speed dial compartment cover.

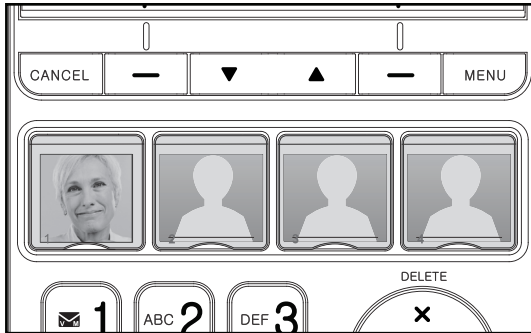

Telephone settings

Using the menu

You can use the menu of the telephone base or a cordless handset to change the telephone settings.

1. Press **MENU** when the handset/telephone base is not in use.
2. Press ▼ or ▲ until the screen displays the desired feature menu.
3. Press **SELECT** on the cordless handset/**SELECT** on the telephone base to enter that menu.
 - To return to the previous menu, press **CANCEL** on the cordless handset/**CANCEL** or **BACK** on the telephone base.
 - To return to idle mode, press and hold **CANCEL**.

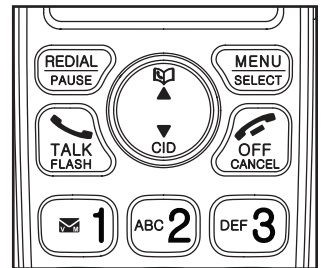
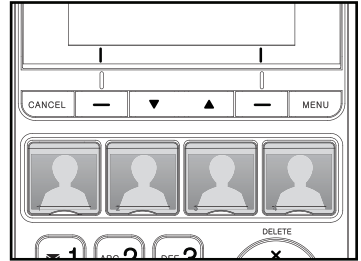

Telephone settings

Ringer volume

You can set the ringer volume or turn the ringer off. When the ringer is off, the screen displays **Ringer off**, **Caller ID won't be announced** and .

1. Press **MENU** when the handset/telephone base is not in use.
2. Press **▼** or **▲** to scroll to **Ringers**, then press **SELECT**.
3. Press **SELECT** to select **Ringer volume**.
4. Press **▼** or **▲** to sample each volume level.
5. Press **SELECT** on the cordless handset/**SET** on the telephone base to save your selection and return to the previous menu. You hear a confirmation tone.

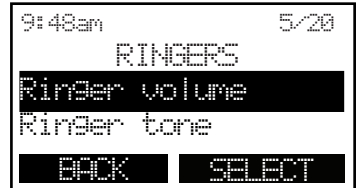

- OR -

- Press **VOL-** or **VOL+** on the handset when it is not in use.

- OR -

- Press **▼ VOL** or **▲ VOL** on the telephone base when it is not in use, and then press **SET**.

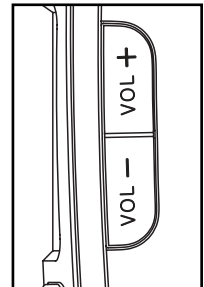

- OR -

- Press **+** or **-** on the pendant when it is not in use. When the pendant ringer is set to off, you hear two beeps.

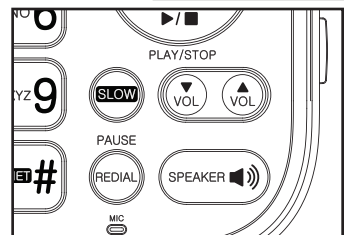

note

If the ringer volume is set to off, that device is silenced for all incoming calls. However, it still rings when being paged.

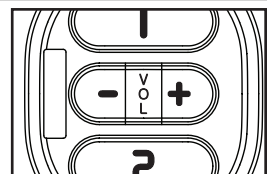

Telephone settings

Ringer tone

You can choose from different ringer tones for each handset, pendant and the telephone base.

Cordless handset/telephone base ringer tone:

1. Press **MENU** when the handset/telephone base is not in use.
2. Press **▼** or **▲** to scroll to **Ringers**, then press **SELECT** on the cordless handset/**SELECT** on the telephone base.
3. Press **▼** or **▲** to scroll to **Ringer tone**, then press **SELECT** on the cordless handset/**SELECT** on the telephone base.
4. Press **▼** or **▲** to scroll to sample each ringer tone.
5. Press **SELECT** on the cordless handset/**SELECT** on the telephone base. You hear a confirmation tone.

note

If you turn off the ringer volume on a cordless handset/telephone base, you will not hear ringer tone samples.

Pendant ringer tone:

1. Press **MENU** when the handset/telephone base is not in use.
2. Press **▼** or **▲** to scroll to **Pendant**, then press **SELECT** on the cordless handset/**SELECT** on the telephone base.
3. Press **▼** or **▲** to scroll to **Pendant ringer**, then press **SELECT** on the cordless handset/**SELECT** on the telephone base.
4. Press **▼** or **▲** to scroll to sample each ringer tone.
5. Press **SELECT** on the cordless handset/**SELECT** on the telephone base. You hear a confirmation tone.

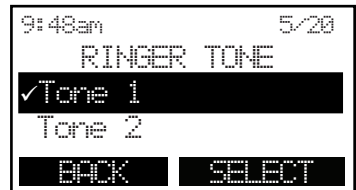

Telephone settings

Set date and time

The answering system announces the date and time of each message prior to playing it. Before using the answering system or reminder, set the date and time as follows. If you subscribe to caller ID service, the day, month and time are set automatically with each incoming call. Make sure the settings are correct so that the reminder feature and answering system work properly.

1. Press **MENU** when the handset/base is not in use.
2. Press ▼ or ▲ to scroll to **Set date/time**, then press **SELECT**.
3. Press ▼ or ▲ to select the month then press **SELECT** on the cordless handset/**NEXT** on the telephone base, or use the dialing keys to enter a two-digit number (**01-12**).
4. Press ▼ or ▲ to select the date then press **SELECT** on the cordless handset/**NEXT** on the telephone base, or use the dialing keys to enter a two-digit number (**01-31**).
5. Press ▼ or ▲ to select the year then press **SELECT** on the cordless handset/**NEXT** on the telephone base, or use the dialing keys to enter a two-digit number (**00-99**) then press **SELECT** on the cordless handset/**NEXT** on the telephone base.
6. Press ▼ or ▲ to select the hour then press **SELECT** on the cordless handset/**NEXT** on the telephone base, or use the dialing keys to enter a two-digit number (**01-12**).
7. Press ▼ or ▲ to select the minute then press **SELECT** on the cordless handset/**NEXT** on the telephone base, or use the dialing keys to enter a two-digit number (**00-59**).
8. Press ▼ or ▲ to select **AM** or **PM**.
9. Press **SELECT** on the cordless handset/**SAVE** on the telephone base. You hear a confirmation tone.

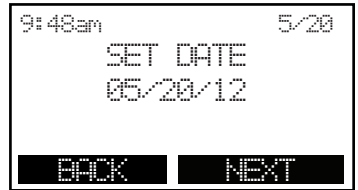

Telephone settings

Set date and time

note

- If the date and time are not set when a message is recorded, the system announces, *"Time and date not set,"* before each message plays.
- The telephone plays two beeps if you enter an invalid number.

Voice Announce[®] caller ID

The voice announce caller ID feature lets you know who's calling without having to look at the display. When you have an incoming call, the handset and/or base speaks *"Call from..."* and the name of the caller based on the phonebook or caller ID information. If the caller's name is private or unknown, the phone number up to the last 11 digits will be announced. If the caller's phone number is also private or unknown, no information will be announced.

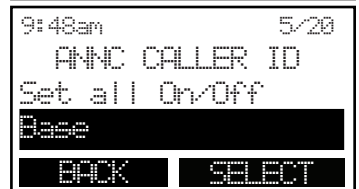

1. Press **MENU** when the handset/base is not in use.
2. Press ▼ or ▲ to scroll to **Annc Caller ID**, then press **SELECT** on the cordless handset/**SELECT** on the telephone base.
3. Press ▼ or ▲ to scroll to the desired option, then press **SELECT** on the cordless handset/**SELECT** on the telephone base.
 - **Set all On/Off** - Change the setting for all devices.
 - **Local handset** - Change the setting for that handset only.
 - **Base** - Change the setting for the telephone base only.
 - **Pendant** - Change the setting for the pendant only.
4. Press ▼ or ▲ to scroll to **On** or **Off**, then press **SELECT** on the cordless handset/**SELECT** on the telephone base. The screen displays **Annc CID ON on all devices** or **Annc CID OFF on all devices**. You hear a confirmation tone.

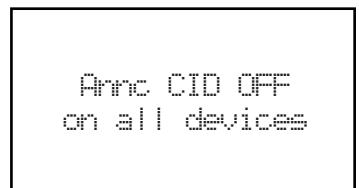

Telephone settings

Voice Announce® caller ID

note

- To use the caller ID announce feature, you must subscribe to caller ID service from your telephone service provider.
- When there are up to five handsets registered, the telephone system supports caller ID announce for all handsets. If six or more handsets are registered, the system supports caller ID announce for the first four registered handsets only.
- This feature does not announce information for call waiting calls.
- It takes at least 2 rings for the phone to receive caller ID information and announce it. If the phone is answered before the end of the second ring, the phone won't have time to announce the caller's information.
- Pronunciation of names may vary with this feature. Not all names may be pronounced correctly.
- Caller ID announce is available in English only.

Telephone settings

LCD language

You can select a language (English, French or Spanish) to be used in all screen displays.

1. Press **MENU** when the handset/base is not in use.
2. Press ▼ or ▲ to scroll to **Settings**, then press **SELECT** on the cordless handset/**SELECT** on the telephone base.
3. Press **SELECT** on the cordless handset/**SELECT** on the telephone base to select **LCD language**.
4. Press ▼ or ▲ to scroll to select **English**, **Français** or **Español**, then press **SELECT** on the cordless handset/**SELECT** on the telephone base.
 - The screen displays **Set English as LCD language?** when you choose **English**.
 - The screen displays **Set Français as LCD language?** when you choose **Français**.
 - The screen displays **Set Español as LCD language?** when you choose **Español**.
5. Press **SELECT** on the cordless handset/**YES** on the telephone base. You hear a confirmation tone.



Telephone settings

Talking digit



You can select the volume or turn off the audible spoken tone that is spoken when you press the dialing key while predialing.

1. Press **MENU** when the handset/base is not in use.
2. Press ▼ or ▲ to scroll to **Settings**, then press **SELECT** on the cordless handset/**SELECT** on the telephone base.
3. Press ▼ or ▲ to scroll to **Talking Digit**, then press **SELECT** on the cordless handset/**SELECT** on the telephone base.
4. Press ▼ or ▲ to scroll to sample each volume level, then press **SELECT** on the cordless handset/**SET** on the telephone base. You hear a confirmation tone.



Telephone settings

Voice mail number

If you subscribe to voicemail service offered by your telephone service provider, you can save the voicemail number to  **1** on the handset or telephone base for easy access. When you want to retrieve voicemail messages, press and hold  **1**. Contact your telephone service provider for more information and assistance about using your voicemail service.

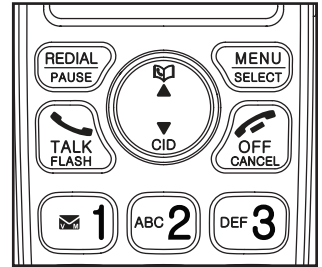

1. Press and hold  **1** when the handset/base is not in use.
2. Enter the voicemail access number provided by your telephone service provider (up to 30 digits) when prompted.
 - Press **▼** or **▲** to move the cursor to the left or right.
 - Press **DELETE** on the cordless handset/**BACKSPACE** or **X/DELETE** on the telephone base to erase a digit.
 - Press and hold **DELETE** to erase all digits.
 - Press and hold **PAUSE** to enter a dialing pause (a **P** appears).
3. Press **SELECT** on the cordless handset/**SAVE** on the telephone base. You hear a confirmation tone. The handset screen displays **Voice mail # saved** and the telephone base screen displays **Voice mail no. saved**.

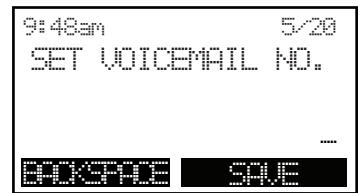
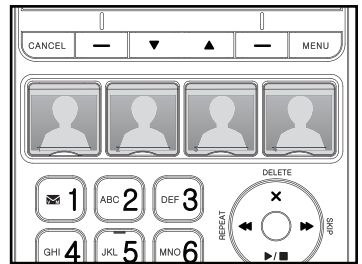

Telephone settings

Voicemail number

-OR-

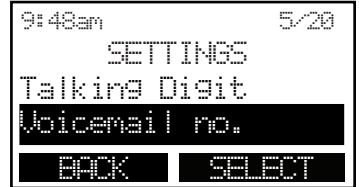

1. Press **MENU** when the handset/base is not in use.
2. Press ▼ or ▲ to scroll to **Settings**, then press **SELECT** on the cordless handset/**SELECT** on the telephone base.
3. Press ▼ or ▲ to scroll to **Voicemail #** on the cordless handset/**Voicemail no.** on the telephone base, then press **SELECT** on the cordless handset/**SELECT** on the telephone base.
4. Enter the voicemail access number provided by your telephone service provider (up to 30 digits) when prompted.
 - Press ▼ or ▲ to move the cursor to the left or right.
 - Press **DELETE** on the cordless handset/**BACKSPACE** or **X/DELETE** on the telephone base to erase a digit.
 - Press and hold **DELETE** to erase all digits.
 - Press and hold **PAUSE** to enter a dialing pause (a **P** appears).
5. Press **SELECT** on the cordless handset/**SAVE** on the telephone base. You hear a confirmation tone. The handset screen displays **Voicemail # saved** or the telephone base screen displays **Voicemail no. saved**.



Telephone settings

Clear voicemail indicators

If you subscribe to voicemail service offered by your telephone service provider,

New voicemail and  appear on the handset/**New voicemail** and  on the telephone base when you have new voicemail messages.

Contact your telephone service provider for more information and assistance about using your voicemail service.

After you have listened to all new voicemail messages, the indicators on the handset and the telephone base turn off automatically.

Use the clear voicemail feature when the telephone indicates that there is new voicemail but there are none (for example, when you have accessed your voicemail while away from home). Clearing the voicemail waiting indicator only turns off the indicators; it does not delete your voicemail messages. As long as you have new voicemail messages, your telephone service provider continues to send the signal to turn on the indicators.

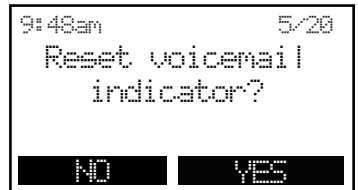
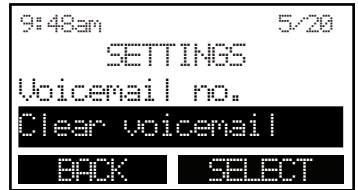

1. Press **MENU** when the handset/base is not in use.
2. Press **▼** or **▲** to scroll to **Settings**, then press **SELECT** on the cordless handset/**SELECT** on the telephone base.
3. On the handset, press **▼** or **▲** to scroll to **Clr voicemail**, then press **SELECT**. The screen displays **Reset Voicemail Indicator?**

-OR-

On the telephone base, press **▼** or **▲** to scroll to **Clear voicemail**, then press **SELECT**. The screen displays **Reset voicemail indicator?**

4. Press **SELECT** on the cordless handset/**YES** on the telephone base. You hear a confirmation tone.

note

Your telephone service provider may alert you of new messages with a stutter (broken) dial tone. Contact your telephone service provider for details.

Telephone settings

Rename base/handset

You can create a name for each system handset and the telephone base.

1. Press **MENU** when the handset/base is not in use.
2. Press ▼ or ▲ to scroll to **Settings**, then press **SELECT** on the cordless handset/**SELECT** on the telephone base.
3. On the handset, press ▼ or ▲ to scroll to **Rename handset**, then press **SELECT**.

-OR-

On the telephone base, press ▼ or ▲ to scroll to **Rename base**, then press **SELECT**.

4. Use the dialing keys to enter the desired name, then press **SELECT** on the cordless handset/**SAVE** on the telephone base. You hear a confirmation tone.

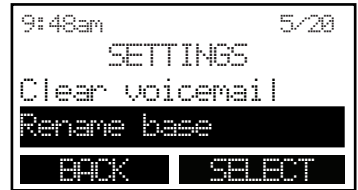

Key tone

You can turn the key tone on or off for each handset and the telephone base.

If you turn the key tone on, the handset/telephone base beeps with each key press. If you turn the key tone off, there are no beeps when you press the handset/telephone base keys.

1. Press **MENU** when the handset/base is not in use.
2. Press ▼ or ▲ to scroll to **Settings**, then press **SELECT** on the cordless handset/**SELECT** on the telephone base.
3. Press ▼ or ▲ to scroll to **Key tone**, then press **SELECT** on the cordless handset/**SELECT** on the telephone base.
4. Press ▼ or ▲ to scroll to sample each volume level, then press **SELECT** on the cordless handset/**SET** on the telephone base. You hear a confirmation tone.

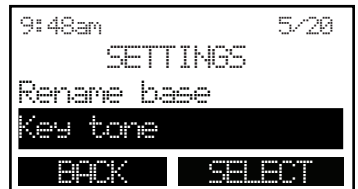

Telephone settings

Use caller ID to automatically set date and time

If you subscribe to caller ID service, the day, month and time are set automatically with each incoming call. This feature allows you to choose whether the time and date are set by incoming caller ID information. The default setting is **On**.

1. Press **MENU** when the handset/base is not in use.
2. Press **▼** or **▲** to scroll to **Settings**, then press **SELECT** on the cordless handset/**SELECT** on the telephone base.
3. Press **▼** or **▲** to scroll to **CID time sync**, then press **SELECT** on the cordless handset/**SELECT** on the telephone base.
4. Press **▼** or **▲** to scroll to **On** or **Off**, then press **SELECT** on the cordless handset/**SELECT** on the telephone base. You hear a confirmation tone.

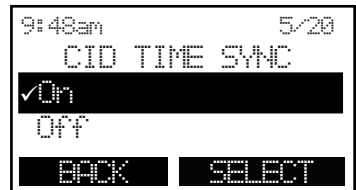

Telephone settings

Home area code

If you dial your local calls using only seven digits (area code not required), you can program your home area code so that when you receive a call within your local area, the telephone number is automatically stored without the area code in the caller ID log.

1. Press **MENU** when the handset/base is not in use.
2. Press **▼** or **▲** to scroll to **Settings**, then press **SELECT** on the cordless handset/**SELECT** on the telephone base.
3. Press **▼** or **▲** to scroll to **Home area code**, then press **SELECT** on the cordless handset/**SELECT** on the telephone base. The screen displays **Only for 7-digit dial from CID**.
4. Use the dialing keys (**0-9**) to enter a three-digit home area code, then press **SELECT** on the cordless handset/**SAVE** on the telephone base. You hear a confirmation tone.

note

If, in the future, your telephone service provider requires you to dial the area code when making a local call, or, if you move to a location that requires it, follow the steps above to delete the home area code you have already programmed. After you have deleted the home area code, _ _ _ will appear on the screen.

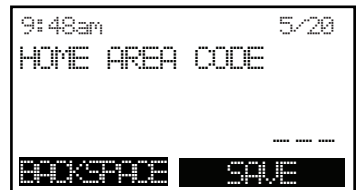
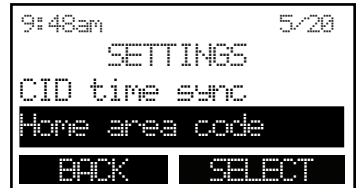

Telephone settings

Dial mode

The dial mode is preset to touch-tone dialing. If you have pulse (rotary) service, you must change the dial mode to pulse dialing before using the telephone to make a call.

1. Press **MENU** the handset/base is not in use.
2. Press ▼ or ▲ to scroll to **Settings**, then press **SELECT** on the cordless handset/**SELECT** on the telephone base.
3. Press ▼ or ▲ to scroll to **Dial mode**, then press **SELECT** on the cordless handset/**SELECT** on the telephone base.
4. Press ▼ or ▲ to scroll to select **Touch-tone** or **Pulse**, then press **SELECT** on the cordless handset/**SELECT** on the telephone base. You hear a confirmation tone.

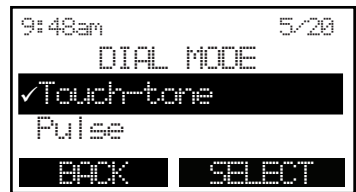



Telephone settings

Quiet mode

You can turn on the quiet mode for a period of time (1-12 hours). During this period, all tones (except paging tone) and call screening are muted.

When you turn on the quiet mode, the answering system turns on automatically. When the quiet mode duration expires, the answering system remains on.

To set and turn on the quiet mode:

1. Press and hold **QUIET#** on the cordless handset/**QUIET#** on the telephone base when the handset/base is not in use. The screen shows **Quiet: __ hours (1-12 hours)**.
2. Use the dialing keys to enter the desired duration (1-12), then press **SELECT** on the cordless handset/**SELECT** on the telephone base. The handset/telephone base screen displays **Answering sys is ON** briefly and then all screens display **Quiet mode on, ANS ON** and . The **ANS**  light on the telephone base turns on.

To turn the quiet mode off:

- While the quiet mode is on, press and hold **QUIET#** on the cordless handset/**QUIET#** on the telephone base. The screen displays **Quiet mode is off** briefly and then returns to idle.

note

When you change the settings of the ringer tone or ringer volume, you can still hear the samples even if the quiet mode is on.

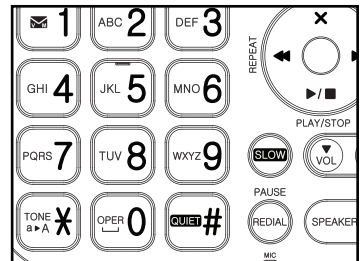
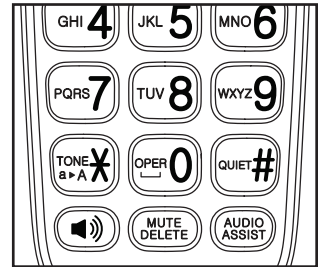

Telephone settings

Voice command

By saying certain commands to the pendant, you can hear information such as the date or time, or call photo speed dial numbers, or even review call log, messages or reminders. You can turn the pendant voice command feature on or off.

1. Press **MENU** when the handset/base is not in use.
2. Press ▼ or ▲ to scroll to **Pendant**, then press **SELECT** on the cordless handset/**SELECT** on the telephone base.
3. Press ▼ or ▲ to scroll to **Voice command**, then press **SELECT** on the cordless handset/**SELECT** on the telephone base.
4. Press ▼ or ▲ to scroll to **On** or **Off**, then press **SELECT** on the cordless handset/**SAVE** on the telephone base. You hear a confirmation tone.

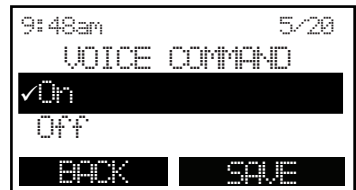
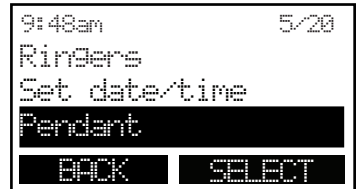

Telephone settings

Happy message

Happy messages are pendant greeting messages. It will occur when you pick up the pendant in the morning (between 4:30am and 9:00am), place the pendant in its charger at night (between 8:00pm and 11:00pm), or after using the voice command feature. The default setting is **On**.

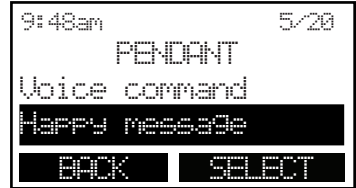
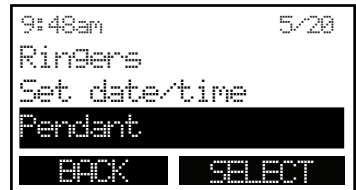

1. Press **MENU** when the handset/base is not in use.
2. Press **▼** or **▲** to scroll to **Pendant**, then press **SELECT** on the cordless handset/**SELECT** on the telephone base.
3. Press **▼** or **▲** to scroll to **Happy message**, then press **SELECT** on the cordless handset/**SELECT** on the telephone base.
4. Press **▼** or **▲** to scroll to **On** or **Off**, then press **SELECT** on the cordless handset/**SAVE** on the telephone base. You hear a confirmation tone.



Telephone operation

Make a call

To make a call on a cordless handset:

1. Press  or .
2. When you hear a dial tone, dial the number.

To make a call at the telephone base:

1. Lift the corded handset, or press **SPEAKER** .
2. When you hear a dial tone, dial the number.

note



- The screen displays the elapsed time as you talk (in hours, minutes and seconds).
- While entering numbers, press and hold **PAUSE** to insert a dialing pause (a **P** appears).

To make a call on a pendant:

Press **1** or **2** to dial the corresponding speed dial number.

Predial a call

To predial a call on a cordless handset:

1. Enter the telephone number.
 - Press **DELETE** to make corrections.
2. Press  or  to dial.

To predial a call at the telephone base:

1. Enter the telephone number.
 - Press **X/DELETE** to make corrections.
2. Lift the corded handset, or press /**SPEAKER** to dial.

note

- The screen displays the elapsed time as you talk (in hours, minutes and seconds).
- While entering numbers, press and hold **PAUSE** to insert a dialing pause (a **P** appears).

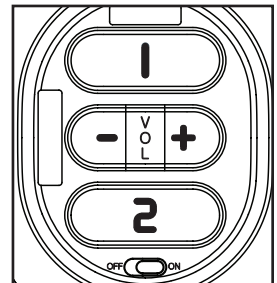
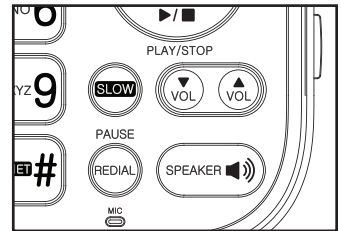
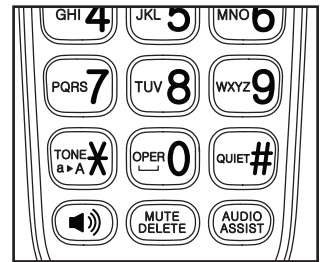
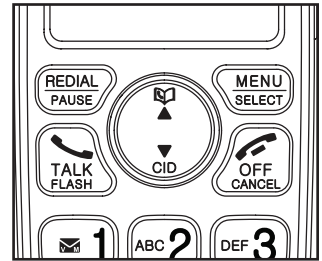

Telephone operation

Answer a call

To answer a call on a cordless handset:

- Press  or any dialing key (0-9 or ).

To answer a call at the telephone base:

- Lift the corded handset, or press **SPEAKER**  or any dialing key (0-9 or .

To answer a call on a pendant:

- Press .

End a call

To end a call on a cordless handset:

- Press **OFF** or place the handset in the handset charger.

To end a call at the telephone base:

- When you are using the corded handset, place it on the telephone base.
- When you are using the base speakerphone, press **SPEAKER** .

To end a call on a pendant:

- Press  or place the pendant in the pendant charger.

Speakerphone

Handset speakerphone:

When the cordless handset is on a call, press  to switch between the handset speakerphone and the handset earpiece.

When the speakerphone is active, the handset displays **Speaker** and the  light turns on.

Telephone base speakerphone:

When the corded handset is on a call, press **SPEAKER**  to switch between the telephone base speakerphone and the corded handset.

When the speakerphone is active, the telephone base displays **Speaker** and the **SPEAKER**  light turns on.

Telephone operation

Equalizer

The equalizer enables you to change the quality of the audio for both handset earpiece and speakerphone to best suit your hearing. The default setting is **Natural**.

1. Press **MENU** during a call.
2. Press **SELECT** on the cordless handset/**SELECT** on the telephone base to choose **Equalizer**.
3. Press ▼ or ▲ to scroll to **Natural**, **Treble 1**, **Treble 2** or **Bass**, then press **SELECT** on the cordless handset/**SAVE** on the telephone base.

note

- If you switch the call between the handset and the speakerphone by pressing **⏪** on the handset or **SPEAKER ⏩** on the telephone base, the audio setting remains unchanged.
- The current equalizer setting remains unchanged until a new setting is selected.

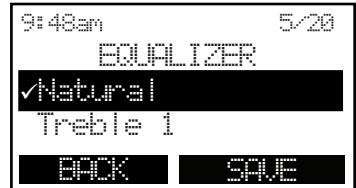

Telephone operation

Audio Assist®

Use the audio assist feature to enhance the clarity and loudness of your caller's voice on the cordless/corded handset earpiece when you are listening to a message or an announcement.

To turn on Audio Assist® :

- While you are on a call or listening to a message or an announcement using the cordless/corded handset earpiece, press **AUDIO ASSIST**. The screen shows **Audio assist on** briefly. The **AUDIO ASSIST** icon appears on the handset screen or the **AUDIO ASSIST** icon appears on the telephone base screen until you turn off this feature.
- You must press **AUDIO ASSIST** every time you want to activate the feature.

To turn off Audio Assist® :

- Press **AUDIO ASSIST** again. The screen shows **Audio assist off** briefly.

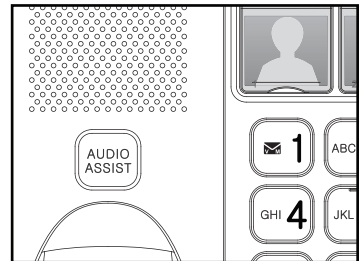
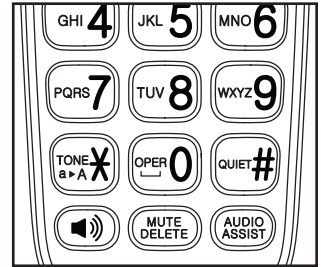

note

Audio Assist deactivates when you end the call.

Telephone operation

Volume control

To adjust the listening volume on a cordless handset:

- During a call, press **VOL-** or **VOL+**.

To adjust the listening volume at the telephone base:

- During a call, press **▼VOL** or **▲VOL** and then press **SET**.

To adjust the listening volume at a pendant:

- During a call, press **VOL-** or **VOL+**.

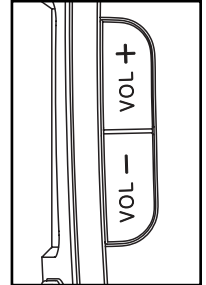

Mute

The mute function allows you to hear the other party but the other party cannot hear you.

To mute a call on a cordless handset:

- During a call, press **MUTE**. The handset displays **Muted** briefly and **MUTE** icon until the mute function is turned off.
- Press **MUTE** again to resume the conversation. The handset displays **Microphone ON** briefly.

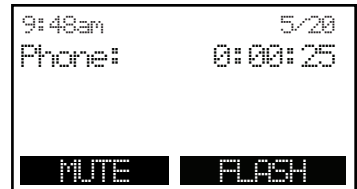

To mute a call at the telephone base:

- During a call, press **MUTE**. The telephone base displays **Muted** briefly and **MUTE** icon until the mute function is turned off.
- Press **UNMUTE** to resume the conversation. The telephone base displays **Microphone ON** briefly.



Telephone operation

Call waiting

If you subscribe to call waiting service from your telephone service provider, you hear an alert tone when there is an incoming call while you are already on another call.

- Press **FLASH** on the handset/**FLASH** on the telephone base to put your current call on hold and take the new call.
- Press **FLASH** on the handset/**FLASH** on the telephone base to switch back and forth between calls.

Temporary ringer silencing

When the telephone is ringing, you can temporarily silence the ringer of the handset or the telephone base without disconnecting the call. The next call rings normally at the preset volume.

To silence the ringer temporary on a cordless handset:

- Press **MUTE**, **CANCEL** or **QUIET** and it displays **Ringer muted** and .

To silence the ringer temporary at the telephone base:

- Press **MUTE**, **CANCEL** or **QUIET#** and it displays **Ringer muted** and .

To silence the ringer temporary at the pendant:

- Press **VOL-**.

note

Each handset, pendant and the base ring when there is an incoming call unless the ringer volume on that device is turned off.

Telephone operation

Redial

The last 10 telephone numbers dialed (up to 30 digits) are stored in the system memory.

Each handset and the telephone base store the last 10 telephone numbers dialed (up to 30 digits) independently. When there are already 10 entries, the oldest entry is deleted to make room for the new entry.

To review and dial a redial number on a cordless handset:

1. Press **REDIAL** when the phone is not in use.
2. Press **▼**, **▲** or **REDIAL** repeatedly to browse.
 - Press **DELETE** to delete the displayed redial entry. You hear a confirmation tone.
3. When the desired entry displays, press **TALK** or **☎** to dial.

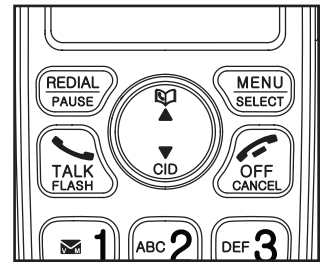

-OR-

1. Press **TALK** or **☎** when the phone is not in use.
2. Press **REDIAL**.
3. Press **▼**, **▲** or **REDIAL** repeatedly to browse.
 - Press **DELETE** to delete the displayed redial entry. You hear a confirmation tone.
4. When the desired entry displays, press **SELECT** to dial or press **CANCEL** to exit.

Telephone operation

Redial

To review and dial a redial number at the telephone base:

1. Press **REDIAL** when the phone is not in use.
2. Press **▼**, **▲** or **REDIAL** repeatedly to browse.
 - Press **X/DELETE** to delete the displayed redial entry. You hear a confirmation tone.
3. When the desired entry displays, lift the corded handset or press **SPEAKER** **◀▶** to dial.

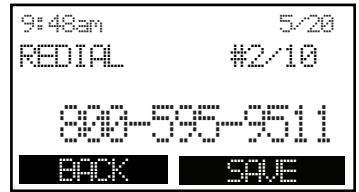

-OR-

1. Lift the corded handset or press **SPEAKER** **◀▶** when the phone is not in use.
2. Press **REDIAL**.
3. Press **▼**, **▲** or **REDIAL** repeatedly to browse.
 - Press **X/DELETE** to delete a redial entry. You hear a confirmation tone.
4. When the desired entry displays, press **CALL** to dial or press **BACK** to exit.

Temporary tone dialing

If you have pulse (rotary) service only, you can switch from pulse to touch-tone dialing temporarily during a call. This is useful if you need to send touch-tone signals to access your telephone banking or long distance services.

1. During a call, press **TONES** **▶▶** **X**.
2. Enter the number you wish to dial. The telephone sends touch-tone signals. It automatically returns to pulse dialing mode after you end the call.

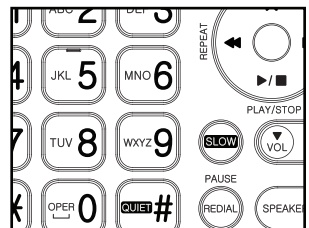

Telephone operation

Check voicemail

Press and hold  1 on the cordless handset/telephone base to dial your voicemail number.

note

To set the voicemail number, see **Voicemail number** on page 40.

Web address

Use this feature to view the VTech website address.

1. Press **MENU** when the handset/base is not in use.
2. Press **▼** or **▲** to scroll to **Web address**, then press **SELECT** on the cordless handset/**SELECT** on the telephone base. Press **OK** on the telephone base to return to the previous menu.

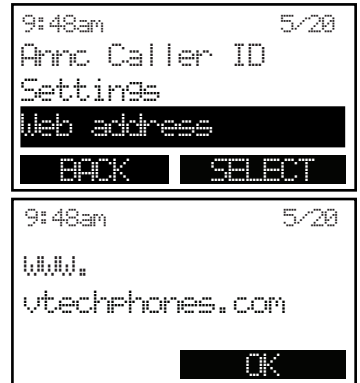

Telephone operation

Chain dialing

Use this feature on the cordless handsets or the telephone base to initiate a dialing sequence from numbers stored in the phonebook, caller ID log or redial list while you are on a call.

Chain dialing can be useful if you wish to access other numbers (such as bank account numbers or access codes) from the directory, caller ID log or redial list.

To access a number from the phonebook while on a call:

1. Press **MENU**.
2. Press **▼** or **▲** to scroll to **Phonebook**, then press **SELECT** on the cordless handset/**SELECT** on the telephone base.
3. Press **▼** or **▲** to scroll to the desired entry, then press **SELECT** on the cordless handset/**CALL** on the telephone base to dial the displayed number.

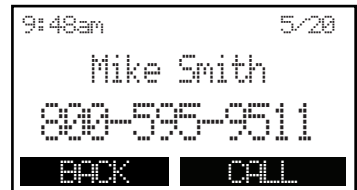

To access a number from the caller ID log while on a call:

1. Press **MENU**.
2. Press **▼** or **▲** to scroll to **Caller ID log**, then press **SELECT** on the cordless handset/**SELECT** on the telephone base.
3. Press **▼** or **▲** to scroll to the desired entry, then press **SELECT** on the cordless handset/**CALL** on the telephone base to dial the displayed number.

To access a number from the redial list while on a call:

1. Press **REDIAL** to enter the redial list.
2. Press **▼**, **▲** or **REDIAL** repeatedly to browse to the desired entry.
3. Press **SELECT** on the cordless handset/**CALL** on the telephone base to dial the displayed number.

note

Press **CANCEL** on the cordless handset or **BACK** on the telephone base to exit the phonebook, caller ID log or redial list while on a call.

Telephone operation

Transfer a call

While on an outside call, you can transfer the call from a cordless handset or the telephone base to another system device.

To transfer a call from a cordless handset:

1. During a call, press **MENU**. Press ▼ or ▲ to scroll to **Transfer**, then press **SELECT**.
 - If you have two or more handsets/pendants, your handset shows **TRANSFER TO:** Press ▼ or ▲ to scroll to the desired device and then press **SELECT**. You may also enter a destination handset number (1-9), or enter 0 for the telephone base, ^{tone}_{a>A} followed by 0-2 for **HANDSET 10** to **HANDSET 12**, or ^{tone}_{a>A} followed by # for all devices.

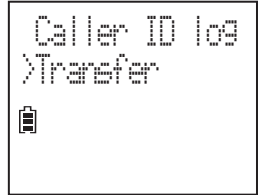

Caller ID log
>Transfer
☎

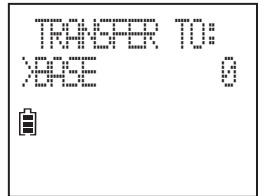

TRANSFER TO:
>BASE 0
☎

The outside call is put on hold and the handset shows **Transferring call.../Transferring call to all...**

The destination device rings and shows **Transfer from HANDSET X.**

2. To answer the call on the destination handset, press ^{TALK} or any dialing key (0-9 or ^{tone}_{a>A}).

-OR-

To answer the call on the telephone base, lift the corded handset, or press **SPEAKER** or any dialing key (0-9 or ^{tone}_{a>A}).

-OR-

To answer the call on the pendant, press ^{hook}.

Telephone operation

Transfer a call

To transfer a call from the telephone base:

1. During a call, press **MENU**. Press ▼ or ▲ to scroll to **Transfer**, then press **SELECT**.
 - If you have two or more handsets/pendants, your handset shows **TRANSFER TO:** Press ▼ or ▲ to scroll to the desired device and then press **SELECT**. You may also enter a destination handset number (1-9), or enter **0** for the telephone base, ^{tone}_{a▶A} **X** followed by **0-2** for **HANDSET 10** to **HANDSET 12**, or ^{tone}_{a▶A} **X** followed by **#** for all devices.

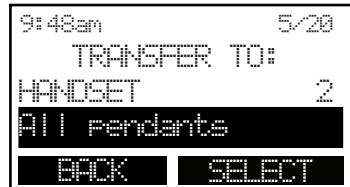

The outside call is put on hold and the telephone base shows **Transferring call/Transferring call to all**.

The destination device rings. The destination handset shows **Transfer from BASE 0**.

2. To answer the call on the destination handset, press ^{TALK} (hook icon) or any dialing key (**0-9** or ^{tone}_{a▶A} **X**).

-OR-

To answer the call on the pendant, press ^{TALK} (hook icon).

note

- If the destination device does not answer the call within 30 seconds, the originating device displays **No response to transfer**. The call will be reverted to the originating device.
- If the destination device is in use, in the phonebook or caller ID log, not powered or out of range, the originating device displays **No answer. Try again**. and then reconnects to the outside call.

Telephone operation

Find handset/pendant

This feature helps you find misplaced handsets and pendants.

To start the paging tone:

- Press **FIND HS** on the right side of the telephone base and its screen displays

Paging all devices. All idle handsets and pendants ring and the handsets display

**** Paging **.**

To stop the paging tone:

- Press **TALK OFF** or any dialing key on a cordless handset, or return the cordless handset to its charger.

-OR-

- Press **hook** on a pendant.

-OR-

- Press **STOP**, **CANCEL** or **FIND HS** on the telephone base.

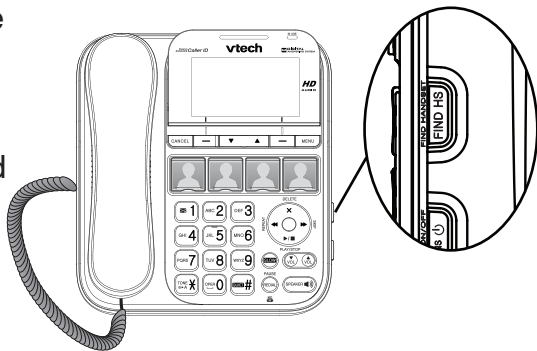

note

Press **MUTE** to mute the ringer of other handsets or press **VOL-** to mute the ringer of other pendants until you find the missing handset or pendant.



Multiple handset use

Join a call in progress



Another handset, pendant or the telephone base can join an outside call. You can share an outside call with the telephone base and up to four handsets/pendants at the same time.

You can buy additional accessory handsets (**SN6107**) or accessory pendants (**SN6166/SN6167**) for the telephone base. You can register up to 12 handsets/pendants to the telephone base.



To join a call with a cordless handset:

- Press  or  to join the call.
- Press **OFF** or place the handset in the handset charger to exit the call.

To join a call with the telephone base:

- Lift the corded handset or press **SPEAKER** .
- Return the corded handset to the telephone base or press **SPEAKER**  to exit the call.

To join a call with a pendant:

- Press  to join the call.
- Press  or place the pendant in the pendant charger to exit the call.

Multiple handset use

Intercom

Use the intercom feature for conversations between two system devices.

To initiate an intercom call with a cordless handset:

1. Press **MENU**, then press ▼ or ▲ to scroll to **Intercom**, then press **SELECT**.



- If you have only one handset, the handset shows **Calling BASE 0**. The telephone base rings and shows **HANDSET 1 is calling**.

- If you have two or more handsets/pendants, your handset shows **INTERCOM TO:** Press ▼ or ▲ to scroll to the desired device and then press **SELECT**. You may also enter a destination handset number (1-9), or enter **0** for the telephone base, ^{tone}_{a>A} **X** followed by **0-2** for **HANDSET 10** to **HANDSET 12**, or ^{tone}_{a>A} **X** followed by **#** for all devices.

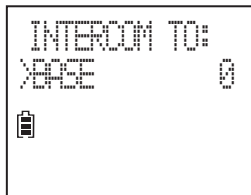

The destination device rings. The destination handset/telephone base shows **HANDSET X is calling/**
HANDSET X is calling all.



Your handset shows **Calling HANDSET X/Calling BASE 0/Calling all pendants/Calling all devices**.

2. To answer the intercom call on the destination handset, press ^{TALK}₉ (📞) or any dialing key (**0-9**, or ^{tone}_{a>A} **X**). Both handsets now show **Intercom**.

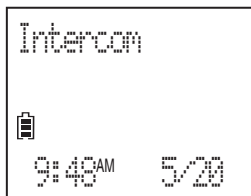

-OR-

To answer the intercom call at the telephone base, lift the corded handset, or press **SPEAKER** (📞) or any dialing key (**0-9**, or ^{tone}_{a>A} **X**). Both devices now show **Intercom**.

-OR-

To answer the intercom call on a pendant, press 📞.

Multiple handset use

Intercom

3. To end the intercom call on either handset, one party presses **OFF**, or places the handset back in the handset charger. Both handsets display **Intercom ended**.

-OR-

To end the intercom call at the telephone base, press **END**, **CANCEL** or **SPEAKER**  when you are using the base speakerphone, or return the corded handset to the telephone base. Both devices display **Intercom ended**.

-OR-

To end the intercom call on the pendant, press  or place the pendant back in the pendant charger.

note

- You can cancel the intercom call before it is answered by pressing **CANCEL**.
- If the destination device is not powered, out of range, on a call, or does not answer the intercom call within 100 seconds, your handset displays **No answer. Try again.** and then returns to idle mode.
- You can press **OFF**, **MUTE** or **QUIET#** on the cordless handset, or **CANCEL**, **MUTE** or **QUIET#** on the telephone base to temporarily silence the intercom ringer.
- Only one intercom call can be established at a time.

Multiple handset use

Intercom

To initiate an intercom call at the telephone base:

1. Press **MENU**, then press ▼ or ▲ to scroll to **Intercom**, then press **SELECT**.
 - If you have only one handset/pendant, the telephone base shows **Calling HANDSET 1/Calling all pendants**. The handset/pendant rings. The handset shows **BASE 0 is calling**.
 - If you have two or more handsets/pendants, your telephone base shows **INTERCOM TO:** Press ▼ or ▲ to scroll to the desired device and then press **SELECT**. You may also enter a destination handset number (1-9), or enter ^{tone} a ▶ A ✕ followed by 0-2 for **HANDSET 10 to HANDSET 12**, or ^{tone} a ▶ A ✕ followed by # for all devices. The destination device rings. The destination handset shows **BASE 0 is calling**.

The telephone base shows **Calling HANDSET X/Calling all pendants/Calling all devices**.

2. To answer the intercom call on the destination handset, press ^{talk} (hook icon), or any dialing key (0-9 or ^{tone} a ▶ A ✕). Both devices now show **Intercom**.

-OR-

To answer the intercom call on the pendant, press ^{hook} (hook icon).

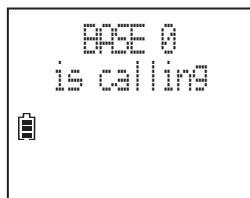
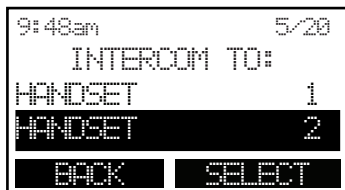

Multiple handset use

Intercom

3. To end the intercom call at the telephone base, press **END**, **CANCEL** or **SPEAKER**  when you are using the base speakerphone, or return the corded handset to the telephone base.

-OR-

To end the intercom call on the destination handset, press **OFF** or place the handset back in the handset charger.

-OR-

To end the intercom call at the pendant, press  or place the pendant back in the pendant charger.

note

- You can cancel the intercom call before it is answered by pressing **CANCEL**.
- If the destination handset/pendant is not powered, out of range, on a call, or does not answer the intercom call within 100 seconds, your telephone base displays **No answer. Try again.** and then returns to idle mode.
- You can press **OFF** or **MUTE** on the cordless handset, or **CANCEL** or **MUTE** on the telephone base to temporarily silence the intercom ringer.
- Only one intercom call can be established at a time.

Multiple handset use



Answer an incoming call during an intercom call

If you receive an incoming outside call during an intercom call, you will hear an alert tone.

To answer on a cordless handset:

- To answer the call, press . The intercom call ends automatically.
- To end the intercom call without answering or canceling the incoming call, press **OFF**. The telephone continues to ring.

To answer at the telephone base:

- Press **SPEAKER**  , or place the corded handset back to the base. The intercom call ends automatically. Then press **SPEAKER**  , or lift up the corded handset to answer the call.
- To end the intercom call without answering or canceling the incoming call, press **SPEAKER**  , or place the corded handset back to the base. The telephone continues to ring.

Multiple handset use

Transfer a call during an intercom call

Use the intercom feature to transfer an outside call to another cordless handset, pendant or the telephone base.

To transfer a call with a cordless handset:

1. During a call, press **MENU**, then press **▼** or **▲** to scroll to **Intercom**, then press **SELECT**.

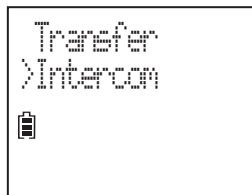

- If you have only one handset, the handset shows **Calling BASE 0**. The telephone base rings and shows **HANDSET 1 is calling**.

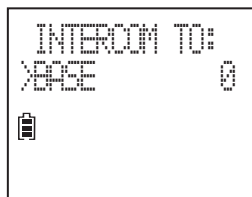

- If you have two or more handsets/pendants, your handset shows **INTERCOM TO:** Press **▼** or **▲** to scroll to the desired device and then press **SELECT**. You may also enter a destination handset number (**1-9**), or enter **0** for the telephone base, ^{TO}_{a>A} **X** followed by **0-2** for **HANDSET 10** to **HANDSET 12**, or ^{TO}_{a>A} **X** followed by **#** for all devices. The destination device rings. The destination handset/telephone base shows **HANDSET X is calling**.

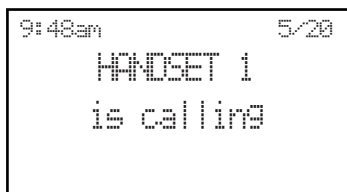

Your handset shows **Calling HANDSET X/Calling BASE 0/Calling all pendants/Calling all devices**.

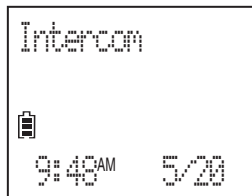

2. To answer the intercom call on the destination handset, press ^{TALK}_{a>A} **X** or any dialing key (**0-9** or ^{TO}_{a>A} **X**). Both handsets now show **Intercom**.

-OR-

To answer the intercom call at the telephone base, lift the corded handset, or press **SPEAKER** ^{TALK}_{a>A} **X** or any dialing key (**0-9** or ^{TO}_{a>A} **X**). Both devices now show **Intercom**.

-OR-

To answer the intercom call on a pendant, press ^{TALK}_{a>A} **X**.

Multiple handset use

Transfer a call during an intercom call

3. To end the intercom call on either handset, one party presses **OFF**, or places the handset back in the handset charger. Both handsets display **Intercom ended**.

-OR-

To end the intercom call at the telephone base, press **END**, **CANCEL** or **SPEAKER**  when you are using the base speakerphone, or return the corded handset to the telephone base. Both devices display **Intercom ended**.

-OR-

To end the intercom call on the pendant, press  or place the pendant back in the pendant charger.

note

- You can cancel the intercom call before it is answered by pressing **CANCEL**.
- If the destination device is not powered, out of range, on a call, or does not answer the intercom call within 100 seconds, your handset displays **No answer. Try again.** and then reconnects to the outside call.

4. From this intercom call, you have the following options:

- You can transfer the call. Press **MENU**, then press **▼** or **▲** to scroll to **Transfer**, then press **SELECT**. Your handset shows **Call transferred**. The destination device is then connected to the outside call.
- You can end the intercom call and continue the outside call with the originating handset. Press  on your handset, or the other party can press **OFF** on the handset, or place the handset back in the handset charger, or place the corded handset back to the base.
- You can let the other device join you on the outside call in a three-way conversation. Press **MENU**, then press **▼** or **▲** to scroll to **Share call**, then press **SELECT** on the originating handset.

Multiple handset use

Transfer a call during an intercom call

To transfer a call at the telephone base:

1. Press **MENU**, then press ▼ or ▲ to scroll to **Intercom**, then press **SELECT**.
 - If you have only one handset/pendant, the telephone base shows **Calling HANDSET 1/Calling all pendants**. The handset/pendant rings. The handset shows **BASE 0 is calling**.
 - If you have two or more handsets/pendants, your telephone base shows **INTERCOM TO:** Press ▼ or ▲ to scroll to the desired device and then press **SELECT**. You may also enter a destination handset number (1-9), or enter ^{tone}**a▶a** **X** followed by 0-2 for **HANDSET 10** to **HANDSET 12**, or ^{tone}**a▶a** **X** followed by # for all devices. The destination device rings. The destination handset shows **BASE 0 is calling**.

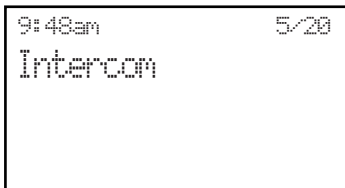
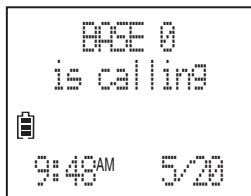
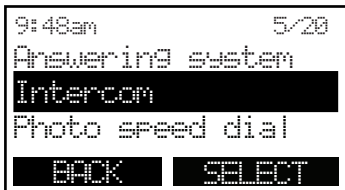

The telephone base shows **Calling HANDSET X/Calling all pendants/Calling all devices**.

2. To answer the intercom call on the destination handset, press **TALK**, **Ⓜ** or any dialing key (0-9 or ^{tone}**a▶a** **X**). Both devices now show **Intercom**.

-OR-

To answer the intercom call on the pendant, press **TALK**.

Multiple handset use

Transfer a call during an intercom call

3. To end the intercom call at the telephone base, press **END**, **CANCEL** or **SPEAKER**  when you are using the base speakerphone, or return the corded handset to the telephone base.

-OR-

To end the intercom call on the destination handset, press **OFF** or place the handset back in the handset charger.



-OR-

To end the intercom call at the pendant, press  or place the pendant back in the pendant charger.

note

- You can cancel the intercom call before it is answered by pressing **CANCEL**.
- If the destination device is not powered, out of range, on a call, or does not answer the intercom call within 100 seconds, your handset displays **No answer. Try again.** and then reconnects to the outside call.

4. From this intercom call, you have the following options:

- You can transfer the call. Press  or place the corded handset back to the telephone base. Both screens display **Intercom ended**. The destination handset is then connected to the outside call.
- The other party can press **OFF** on the handset to end the intercom call. The telephone base reconnects to the outside call.
- You can let the other handset join you on the outside call in a three-way conversation. Press **MENU**, then press  or  to scroll to **Share call**, then press **SELECT** on the telephone base.

Phonebook

About the phonebook

The phonebook stores up to 50 entries with up to 30 digits for each phone number and 15 characters for each name.

- Phonebook entries are shared by all handsets and the telephone base. Any modifications made on one device apply to all.
- When you access the phonebook without records, the screen shows **Phonebook empty**.
- When the phonebook is full and you try to save an entry, the screen shows **Phonebook full**.
- When you try to save an entry already stored in the phonebook, the screen shows **Number already saved**.
- Only one system device can review the phonebook at a time. When a device tries to enter the phonebook while another device is already in it, **Not available at this time** appears.



Phonebook empty



Phonebook full



Number
already saved

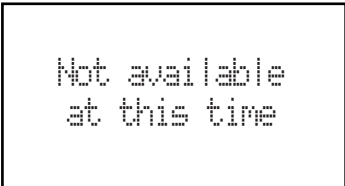

Not available
at this time

Phonebook

Add a phonebook entry

1. Press **MENU** when the handset/telephone base is not in use.

-OR-

When the phonebook is empty, press  on the cordless handset/**PHONEBOOK** on the telephone base. The handset screen displays **Phonebook empty** briefly and then **Add contact?** The telephone base screen displays **Phonebook empty** briefly and then **Add new contact?** Press **SELECT** on the handset/**YES** on the telephone base. Then go to Step 4.

2. Press **▼** or **▲** to scroll to **Phonebook**, then press **SELECT** on the cordless handset/**SELECT** on the telephone base.

3. Press **▼** or **▲** to scroll to **Add contact**, then press **SELECT** on the cordless handset/**SELECT** on the telephone base.

4. When **ENTER NUMBER** displays, use the dialing keys to enter a number (up to 30 digits).

- Press **▼** or **▲** to move the cursor to the left or right.
- Press **DELETE** on the handset/**X/DELETE** or **BACKSPACE** on the telephone base to erase a digit.
- Press and hold **DELETE** on the handset/**X/DELETE** on the telephone base to erase all digits.
- Press and hold **PAUSE** to enter a dialing pause (a **P** appears).

-OR-

Copy a number from the redial list by pressing **REDIAL** then press **▼** or **▲**, or **REDIAL** repeatedly to find the desired number. Press **SELECT** on the cordless handset/**SELECT** on the telephone base to copy the number.

5. Press **SELECT** on the cordless handset/**NEXT** on the telephone base.

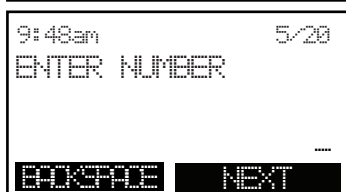

Phonebook

Add a phonebook entry

6. When **ENTER NAME** displays, use the dialing keys to enter a name (up to 15 characters). Each time you press a key, the character on that key appears. Additional key presses produce other characters on that key. Press the key repeatedly until the desired character appears. The first character of each word is capitalized.

- Press ▼ or ▲ to move the cursor to the left or right.
- Press 0 to add a space.
- Press **DELETE** on the handset/**X/DELETE** or **BACKSPACE** on the telephone base to erase a character.
- Press and hold DELETE on the handset/**X/DELETE** on the telephone base to erase all characters.



7. Press **SELECT** on the cordless handset/**SAVE** on the telephone base to save. The screen displays **Saved** and you hear a confirmation tone.

-OR-

1. Use the dialing keys to enter a number (up to 30 digits) when the handset/telephone base is not in use. Press **SELECT** on the cordless handset/**SAVE** on the telephone base. The screen displays **EDIT NUMBER**.

- Press ▼ or ▲ to move the cursor to the left or right.
- Press **DELETE** on the handset/**X/DELETE** or **BACKSPACE** on the telephone base to erase a digit.
- Press and hold DELETE on the handset/**X/DELETE** on the telephone base to erase all digits.
- Press and hold PAUSE to enter a dialing pause (a **P** appears).

-OR-

Copy a number from the redial list by pressing **REDIAL** then press ▼ or ▲, or **REDIAL** repeatedly to find the desired number. Press **SELECT** on the cordless handset/**SELECT** on the telephone base to copy the number.

Phonebook

Add a phonebook entry

2. Press **SELECT** on the cordless handset/**NEXT** on the telephone base.
3. When **ENTER NAME** displays, use the dialing keys to enter a name (up to 15 characters). Each time you press a key, the character on that key appears. Additional key presses produce other characters on that key. Press the key repeatedly until the desired character appears. The first character of each word is capitalized.
 - Press **▼** or **▲** to move the cursor to the left or right.
 - Press **0** to add a space.
 - Press **DELETE** on the handset/**X/DELETE** or **BACKSPACE** on the telephone base to erase a character.
 - Press and hold **DELETE** on the handset/**X/DELETE** on the telephone base to erase all characters.
4. Press **SELECT** on the cordless handset/**SAVE** on the telephone base to save. The screen displays **Saved** and you hear a confirmation tone.

Review phonebook entries

Phonebook entries appear alphabetically.

1. Press  on the cordless handset or **PHONEBOOK** on the telephone base when the phone is not in use to show the first entry in the phonebook.

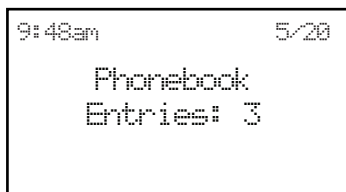

2. Press **▼** or **▲** to browse through the entries.

-OR-

1. Press **MENU** when the phone is not in use.
2. Press **▼** or **▲** to scroll to **Phonebook**, then press **SELECT** on the cordless handset/**SELECT** on the telephone base.



3. Press **SELECT** on the cordless handset/**SELECT** on the telephone base to choose **Review**.
4. Press **▼** or **▲** to browse through the entries.

Phonebook



Alphabetical search

1. Press  on the cordless handset or **PHONEBOOK** on the telephone base when the phone is not in use to show the first entry in the phonebook.
2. Use the dialing keys to enter the letter associated with the name. For example, if you have the entries named Jennifer, Jessie, Kevin and Linda in your phonebook, press **5** (JKL) once to see Jennifer (when Jennifer displays, press ▼ to see Jessie), twice to see Kevin, or three times to see Linda. If necessary, press ▼ or ▲ to browse.

-OR-

1. Press **MENU** when the phone is not in use.
2. Press ▼ or ▲ to scroll to **Phonebook**, then press **SELECT** on the cordless handset/**SELECT** on the telephone base.
3. Press **SELECT** on the cordless handset/**SELECT** on the telephone base to choose **Review**.
4. Use the dialing keys to enter the letter associated with the name. For example, if you have the entries named Jennifer, Jessie, Kevin and Linda in your phonebook, press **5** (JKL) once to see Jennifer (when Jennifer displays, press ▼ to see Jessie), twice to see Kevin, or three times to see Linda. If necessary, press ▼ or ▲ to browse.

Dial a phonebook entry

1. Search for the desired entry in the phonebook (see **Review phonebook entries** on page 76 or **Alphabetical search** above).
2. When the desired entry displays, press  or  on the handset, or **SPEAKER**  on the telephone base to dial.

Phonebook

Edit a phonebook entry

1. Search for the desired entry in the phonebook (see **Review phonebook entries** on page 76 or **Alphabetical search** on page 77).
2. When the desired entry displays, press **SELECT** on the cordless handset/**EDIT** on the telephone base. The screen displays **EDIT NUMBER** and the stored number.
 3. Use the dialing keys to edit the number.
 - Press **▼** or **▲** to move the cursor to the left or right.
 - Press **DELETE** on the handset/**X/DELETE** or **BACKSPACE** on the telephone base to erase a digit.
 - Press and hold **DELETE** on the handset/**X/DELETE** on the telephone base to erase all digits.
 - Press and hold **PAUSE** to enter a dialing pause (a **P** appears).
 4. Press **SELECT** on the cordless handset/**NEXT** on the telephone base. The screen displays **EDIT NAME** and then the stored name.
 5. Use the dialing keys to edit the name.
 - Press **▼** or **▲** to move the cursor to the left or right.
 - Press **0** to add a space.
 - Press **DELETE** on the handset/**X/DELETE** or **BACKSPACE** on the telephone base to erase a character.
 - Press and hold **DELETE** on the handset/**X/DELETE** on the telephone base to erase all characters.
 6. Press **SELECT** on the cordless handset/**SAVE** on the telephone base to save the entry. The screen displays **Saved** and then the revised entry. You hear a confirmation tone.

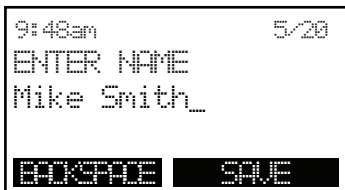
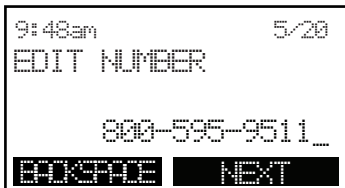

Phonebook

Delete a phonebook entry

1. Search for the desired entry in the phonebook (see **Review phonebook entries** on page 76 or **Alphabetical search** on page 77).
2. Press **DELETE** on the handset/**X/DELETE** on the telephone base to delete the displayed phonebook entry. The screen displays **Delete contact?** with the contact name.
3. Press **SELECT** on the cordless handset/**YES** on the telephone base to confirm. The screen displays **Contact deleted**. You hear a confirmation tone.

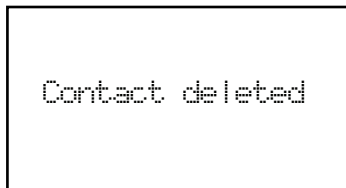

Photo speed dial

The telephone system has four photo speed dial locations, where you can store the telephone numbers you wish to dial more quickly. You can store up to 30 digits in each location. You must set the speed dial numbers to the corresponding locations before using them.

We recommend you store two contacts that you may need to call them more often or right away to photo speed keys **1** and **2**.

Store a photo speed dial entry

1. Press **MENU** on the telephone base when it is not in use. Press **▼** or **▲** to scroll to **Photo speed dial**, press **SELECT**. Press **▼** or **▲** to scroll to the desired speed dial location, then press **SELECT**.

-OR-

When the desired photo speed dial location is empty, press the speed dial key.

2. When **MEMORY X NUMBER** displays, use the dialing keys to enter a number (up to 30 digits):

- Press **▼** or **▲** to move the cursor to the left or right.
- Press **X/DELETE** or **BACKSPACE** to erase a digit.
- Press and hold **X/DELETE** to erase all digits.
- Press and hold **PAUSE** to enter a dialing pause (a **P** appears).

3. Press **NEXT**.

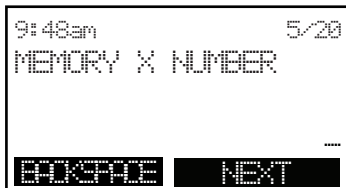
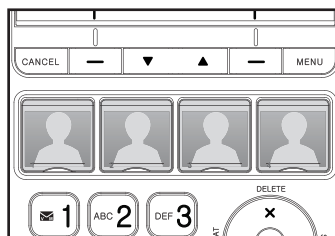

Photo speed dial

Store a photo speed dial entry

4. When **MEMORY X NAME** displays, use the dialing keys to enter a name (up to 15 characters). Each time you press a key, the character on that key appears. Additional key presses produce other characters on that key. Press the key repeatedly until the desired character appears. The first character of each word is capitalized.
- Press ▼ or ▲ to move the cursor to the left or right.
 - Press 0 to add a space.
 - Press **X/DELETE** or **BACKSPACE** to erase a character.
 - Press and hold **X/DELETE** to erase all characters.
5. Press **SAVE**. The screen displays **Memory X saved** and you hear a confirmation tone.

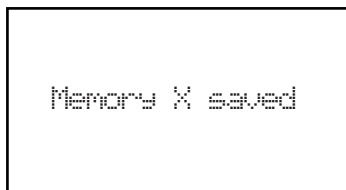
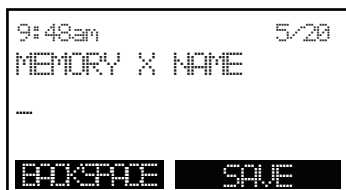

Photo speed dial

Edit a photo speed dial entry

1. Press **MENU** on the telephone base when it is not in use.
2. Press ▼ or ▲ to scroll to **Photo speed dial**, then press **SELECT**.
3. Press ▼ or ▲ to scroll to the desired speed dial location, then press **SELECT**.
4. When **MEMORY X NUMBER** displays, use the dialing keys to edit the telephone number:
 - Press ▼ or ▲ to move the cursor to the left or right.
 - Press **X/DELETE** or **BACKSPACE** to erase a digit.
 - Press and hold X/DELETE to erase all digits.
 - Press and hold PAUSE to enter a dialing pause (a **P** appears).
5. Press **NEXT**.
6. When **MEMORY X NAME** displays, use the dialing keys to edit the contact name.
 - Press ▼ or ▲ to move the cursor to the left or right.
 - Press **0** to add a space.
 - Press **X/DELETE** or **BACKSPACE** to erase a character.
 - Press and hold X/DELETE to erase all characters.
7. Press **SAVE**. The screen displays **Memory X saved** and you hear a confirmation tone.

Photo speed dial

Delete a photo speed dial entry

1. Press **MENU** on the telephone base when it is not in use.
2. Press ▼ or ▲ to scroll to **Photo speed dial**, then press **SELECT**.
3. Press ▼ or ▲ to scroll to the desired speed dial location, then press **X/DELETE**. The screen displays **Clear Memory X?**
4. Press **YES** to confirm. The screen displays **Memory X cleared** and you hear a confirmation tone.

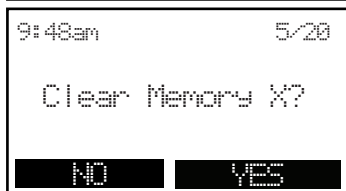
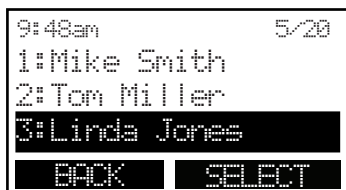

Dial a photo speed dial number

To dial with the telephone base:

- Press a photo speed dial key to dial the number stored in the corresponding photo speed dial location.

To dial with the pendant:

- Press **1** or **2** to dial the number stored in the corresponding photo speed dial location.

-OR-

Use the voice command feature to dial (see page 119).

Caller ID

About the caller ID log

This product supports caller ID services offered by most telephone service providers. Depending on your service subscription, you may see the caller's number, or the caller's name and number that are sent by your telephone service provider after the first or second ring. Caller ID allows you to see the name, number, date and time of calls.

Information about caller ID with call waiting

Caller ID with call waiting lets you see the name and telephone number of the caller before answering the call, even while on another call.

It may be necessary to change your telephone service to use this feature. Contact your telephone service provider if:

- You have both caller ID and call waiting, but as separate services (you may need to combine these services).
- You have only caller ID service, or only call waiting service.
- You do not subscribe to caller ID log or call waiting services.
- There are fees for caller ID services. In addition, services may not be available in all areas.

This product can provide information only if both you and the caller are in areas offering caller ID service and if both telephone service providers use compatible equipment. The time and date, along with the call information, are from the telephone service provider.

Caller ID information may not be available for every incoming call. Callers may intentionally block their names and/or telephone numbers. To view caller ID log entries with numbers between 16 and 24 digits, you must save the entry to the phonebook (see page 90).

You can use this product with regular caller ID service, or you can use this product's other features without subscribing to caller ID or combined caller ID with call waiting service.

Caller ID

Caller ID log

If you subscribe to caller ID service, information about each caller will appear after the first or second ring. If you answer a call before the caller's information appears on the screen, it will not be saved in the caller ID log.

- The caller ID log stores up to 50 entries. Each entry has up to 24 digits for the phone number and 15 characters for the name. If the name has more than 15 characters, only the first 15 characters are shown and saved in the caller ID log.
- Caller ID log entries are shared by all handsets and the telephone base. Any modifications made on one device apply to all.
- You can review, redial, and copy an entry into the phonebook.
- Entries appear in reverse chronological order.
- When the caller ID log is full, the oldest entry is deleted to make room for new incoming call information.
- **XX Missed calls** shows when you have incoming calls that have not been answered.
- **Caller ID log empty** shows when you access the caller ID log without records.
- Only one handset or the telephone base can review the caller ID log at a time. If a system device tries to enter the caller ID log while another system device is already in it, its screen displays **Not available at this time**.

Caller ID

Missed call indicator

When there are calls that have not been reviewed in the caller ID log, the screens display **XX Missed calls**. When you have reviewed all the missed calls, the missed call indicator goes away.

Each time you review a caller ID log entry marked **NEW** on the cordless handset or **NEU** on the telephone base, the number of missed calls decreases by one.

If you do not want to review the missed calls one by one, press and hold **CANCEL** or **DELETE** on the cordless handset or **CANCEL** on the telephone base when not in use to clear the missed call indicator. All the entries are then considered old and kept in the caller ID log.

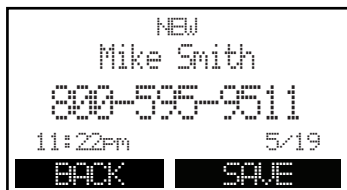
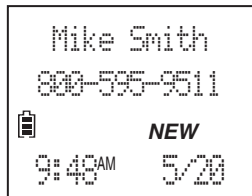
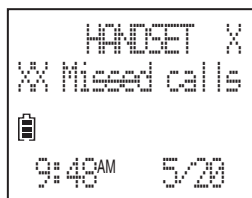

Memory match

When the incoming telephone number matches the last seven digits of a telephone number in your phonebook, the name that appears on the screen matches the corresponding name in your phonebook.

For example, if Linda Jones calls, her name appears as **Linda** if this is how you entered it into your phonebook.

note

The number shown in the caller ID log is in the format sent by the telephone service provider. The telephone service provider usually delivers 10-digit phone numbers (area code plus telephone number). If the phone number of the caller does not match a number in your phonebook, the name will appear as it is delivered by the telephone service provider.

Caller ID

Review the caller ID log

Review the caller ID log to find out who called, to return the call, or to copy the caller's name and number into your phonebook.

To review the caller ID log with a cordless handset/the telephone base:

1. Press **CID** on the cordless handset, or press **CALL LOG** on the telephone base when the phone is not in use.
2. Press ▼ or ▲ to browse.

-OR-

1. Press **MENU** when the phone is not in use.
2. Press ▼ or ▲ to scroll to **Caller ID log**, then press **SELECT** on the cordless handset/**SELECT** on the telephone base.
3. Press **SELECT** on the cordless handset/**SELECT** on the telephone base to choose **Review**.
4. Press ▼ or ▲ to browse through the entries.

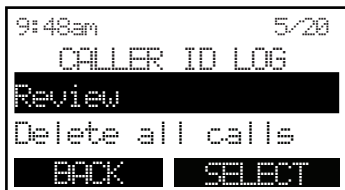

To review the caller ID log with a pendant:

- Use the voice command feature (see page 121).

Caller ID

View dialing options

Although the caller ID log entries received have 10 digits (the area code plus the seven-digit number), in some areas, you may need to dial only the seven digits, or 1 plus the seven digits, or 1 plus the area code plus the seven digits. You can change the number of digits that you dial from the caller ID log and store the new number to the phonebook.

While reviewing the caller ID log, press **QUIET#** on the cordless handset or **QUIET#** on the telephone base repeatedly to display different dialing options for local and long distance numbers before dialing or saving the telephone number in the phonebook.

Press **1** repeatedly if you need to add or remove 1 in front of the telephone number before dialing or saving it in the phonebook.

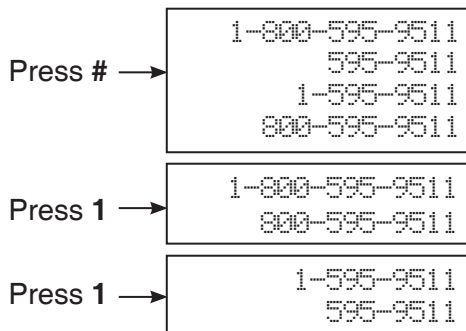

When the number is displayed in the correct format for dialing, press **TALK** or **»** on a cordless handset, or press **SPEAKER** **»** or lift the corded handset on the telephone base to dial.



Caller ID

Dial a caller ID log entry

To dial on a cordless handset:

1. Search for the desired caller ID log entry (see **Review the caller ID log** on page 87).
2. When the desired entry displays, press  or  to dial.

To dial at the telephone base:

1. Search for the desired caller ID log entry (see **Review the caller ID log** on page 87).
2. When the desired entry displays, press **SPEAKER**  or lift the corded handset to dial.

To dial on the pendant:

- Use the voice command feature (see page 121).

Caller ID

Save a caller ID log entry to the phonebook

1. Search for the desired caller ID log entry (see **Review the caller ID log** on page 87).
2. Press **SELECT** on the cordless handset/**SAVE** on the telephone base to choose the entry. The screen displays **EDIT NUMBER** and the stored number.
3. Use the dialing keys to edit the number.
 - Press ▼ or ▲ to move the cursor to the left or right.
 - Press **DELETE** on the handset/**X/DELETE** or **BACKSPACE** on the telephone base to erase a digit.
 - Press and hold **DELETE** on the handset/**X/DELETE** on the telephone base to erase all digits.
 - Press and hold **PAUSE** to enter a dialing pause (a **P** appears).
4. Press **SELECT** on the cordless handset/**NEXT** on the telephone base. The screen displays **EDIT NAME** and the stored name.
5. Use the dialing keys to edit the name. Additional key presses show other characters of that particular key.
 - Press ▼ or ▲ to move the cursor to the left or right.
 - Press **0** to add a space.
 - Press **DELETE** on the handset/**X/DELETE** or **BACKSPACE** on the telephone base to erase a character.
 - Press and hold **DELETE** on the handset/**X/DELETE** on the telephone base to erase all characters.
6. Press **SELECT** on the cordless handset/**SAVE** on the telephone base to save the entry. The screen displays **Saved** and then the revised entry. You hear a confirmation tone.

Caller ID

Delete caller ID log entries

To delete one entry:

1. Search for the desired caller ID log entry (see **Review the caller ID log** on page 87).
2. Press **DELETE** on the handset/**X/DELETE** on the telephone base to delete the displayed entry. You hear a confirmation tone.



To delete all entries:

1. Press **MENU** when the phone is not in use.
2. Press **▼** or **▲** to scroll to **Caller ID log**, then press **SELECT** on the cordless handset/**SELECT** on the telephone base.
3. Press **▼** or **▲** to scroll to **Del all calls** on the cordless handset/**Delete all calls** on the telephone base. Press **SELECT** on the cordless handset/**SELECT** on the telephone base. The screen displays **Delete all calls?**
4. Press **SELECT** on the cordless handset/**YES** on the telephone base. You hear a confirmation tone.



Caller ID log screen messages

Displays:	When:
PRIVATE NAME	The caller is blocking the name information.
PRIVATE NUMBER	The caller is blocking the telephone number information.
PRIVATE CALLER	The caller is blocking the name and number information.
UNKNOWN NAME	This caller's name is unavailable.
UNKNOWN NUMBER	This caller's number is unavailable.
UNKNOWN CALLER	No information is available about this caller.

Reminder

About the reminder

The reminder feature helps remind you of important events. You can set the reminder to remind you only once, or in daily, weekly or monthly bases. Once you set the reminder, the system will alarm you at the alarm time and every 15 minutes after the alarm time for three more times.

Add a reminder

Each reminder can be up to four minutes in length. The total storage capacity for the announcement, messages, memos and reminders is approximately 14 minutes.

To add a reminder with a cordless handset:

1. Press **MENU** when the handset is not in use.
2. Press ▼ or ▲ to scroll to **Reminder**, then press **SELECT**.
3. Press ▼ or ▲ to scroll to **Set reminder**, then press **SELECT**.
4. Press ▼ or ▲ to select the month then press **SELECT**, or use the dialing keys to enter a two-digit number (**01-12**).
5. Press ▼ or ▲ to select the date then press **SELECT**, or use the dialing keys to enter a two-digit number (**01-31**).
6. Press ▼ or ▲ to select the year then press **SELECT**, or use the dialing keys to enter a two-digit number (**00-99**), then press **SELECT**.
7. Press ▼ or ▲ to select the hour then press **SELECT**, or use the dialing keys to enter a two-digit number (**01-12**).
8. Press ▼ or ▲ to select the minute then press **SELECT**, or use the dialing keys to enter a two-digit number (**00-59**).
9. Press ▼ or ▲ to select **AM** or **PM**, then press **SELECT**.



Reminder

Add a reminder

10. The system announces, *“Record after the tone. Press 5 when you are done.”* After the tone, speak towards the microphone.
11. Press **5** when done. The system announces, *“Recorded.”*
12. Press ▼ or ▲ to scroll to the frequency you would like to set, then press **SELECT**. You hear a confirmation tone.
 - **Once** -- Reminder occurs only once at the specific time and date you set.
 - **Daily** -- Reminder occurs every day at the specific time you set.
 - **Weekly** -- Reminder occurs every week at the specific time and day you set.
 - **Monthly** -- Reminder occurs every month at the specific time and date you set.

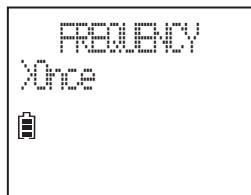
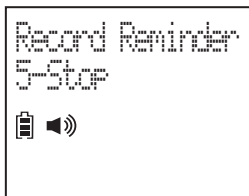

Reminder

Add a reminder

To add a reminder with the telephone base:

1. Press **MENU** when the telephone base is not in use.
2. Press **▼** or **▲** to scroll to **Reminder**, then press **SELECT**.
3. Press **▼** or **▲** to scroll to **Set reminder**, then press **SELECT**.
4. Press **▼** or **▲** to select the month then press **NEXT**, or use the dialing keys to enter a two-digit number (**01-12**).
5. Press **▼** or **▲** to select the date then press **NEXT**, or use the dialing keys to enter a two-digit number (**01-31**).
6. Press **▼** or **▲** to select the year then press **NEXT**, or use the dialing keys to enter a two-digit number (**00-99**), then press **NEXT**.
7. Press **▼** or **▲** to select the hour then press **NEXT**, or use the dialing keys to enter a two-digit number (**01-12**).
8. Press **▼** or **▲** to select the minute then press **NEXT**, or use the dialing keys to enter a two-digit number (**00-59**).
9. Press **▼** or **▲** to select **AM** or **PM**, then press **SELECT**.
10. The system announces, *“Record after the tone. Press **SAVE** when you are done.”* After the tone, speak towards the microphone.
11. Press **SAVE** when done. The system announces, *“Recorded.”*

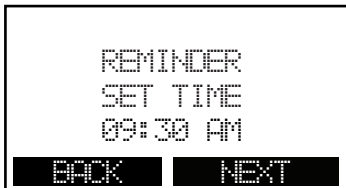
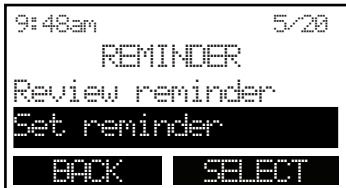

Reminder

Add a reminder

12. Press ▼ or ▲ to scroll to the frequency you would like to set, then press **SAVE**. You hear a confirmation tone.

- **Once** -- Reminder occurs only once at the specific time and date you set.
- **Daily** -- Reminder occurs every day at the specific time you set.
- **Weekly** -- Reminder occurs every week at the specific time and day you set.
- **Monthly** -- Reminder occurs every month at the specific time and date you set.

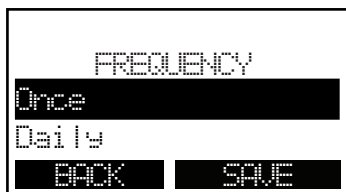

Reminder

Review reminders

When playback begins, the total number of reminders is announced. Before each reminder, you hear the day and time of the recording. After the last reminder, the screen displays **End of reminder** and you hear, “*End of reminder.*”

To play reminders with a cordless handset:

1. Press **MENU** when the handset is not in use.
2. Press ▼ or ▲ to scroll to **Reminder**, then press **SELECT**.
3. Press **SELECT** to select **Review**. The reminders play automatically.

Options during playback:

- Press **VOL+** or **VOL-** to adjust the reminder playback volume.
- Press **4** to repeat the current reminder.
- Press **5** to stop the playback.
- Press **6** to skip to the next reminder.
- Press ◀ to switch between the handset speakerphone and the handset earpiece.
- Press **DELETE** to delete the current reminder. The screen displays **Reminder deleted**. The system announces, “*Reminder deleted.*”

To play reminders with the telephone base:

1. Press **MENU** when the telephone base is not in use.
2. Press ▼ or ▲ to scroll to **Reminder**, then press **SELECT**.
3. Press **SELECT** to select **Review reminder**. The reminders play automatically.

Options during playback:

- Press ▼**VOL** or ▲**VOL** to adjust the reminder playback volume.
- Press ▶/■/**STOP** to stop the playback.
- Press **EDIT** to edit the reminder.
- Press **X/DELETE** to delete the current announcement. The screen displays **Reminder deleted**. The system announces, “*Reminder deleted.*”

To play reminders with a pendant:

- Use the voice command feature (see page 120).

Reminder

Add and review reminders remotely

You can also add or review reminders remotely from any touch-tone telephone. See **Remote access** on page 117 for more information.

Reminder on/off

You can turn the reminder feature on or off.

1. Press **MENU** when the phone is not in use.
2. Press ▼ or ▲ to scroll to **Reminder**, then press **SELECT** on the cordless handset/**SELECT** on the telephone base.
3. Press ▼ or ▲ to scroll to **Reminder on/off**, then press **SELECT** on the cordless handset/**SELECT** on the telephone base.
4. Press ▼ or ▲ to scroll to **On** or **Off**, then press **SELECT** on the cordless handset/**SAVE** on the telephone base. You hear a confirmation tone.

note

When the reminder feature is set to off, it will be automatically turned on after a reminder is recorded. The screen displays **Reminder is turned ON**.

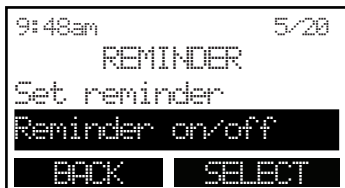

Answering system settings

Answering system

Use the answering system menu of a cordless handset or telephone base to turn on or off the answering system or message alert tone, set up the announcement message, activate the call screening, or change the number of rings, remote access code or message recording time.

When your answering system is turned off and you change any of its settings, the answering system automatically turns on again.

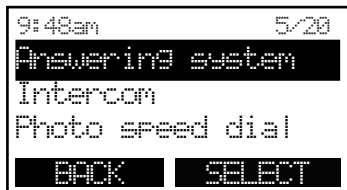

Answering system settings

Announcement

The telephone is preset with a greeting that answers calls with, “*Hello. Please leave a message after the tone.*” You can use this preset announcement, or replace it with your own.

Record your own announcement

You can record an announcement up to 90 seconds, but any announcement shorter than two seconds will not be recorded.

To record an announcement with a cordless handset:

1. Press **MENU** when the handset is not in use.
2. Press ▼ or ▲ to scroll to **Answering sys**, then press **SELECT**.
3. Press **SELECT** again to select **Announcement**.
4. Press **SELECT** again to select **Record annc**.
The system announces, “*Record after the tone. Press 5 when you are done.*” After the tone, speak towards the microphone.
5. Press **5** when done. The answering system automatically plays back the newly recorded announcement, then returns to the previous menu.

-OR-

Press **CANCEL** to return to the previous menu.

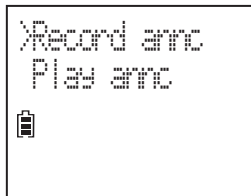
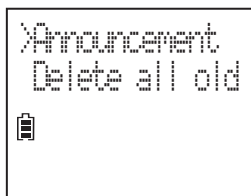

Answering system settings

To record an announcement with the telephone base:

1. Press **MENU** when the base is not in use, then press **SELECT** to select **Answering system**.
2. Press **SELECT** again to select **Announcement**.
3. Press **SELECT** again to select **Record new annnc**. The system announces, "Record after the tone. Press **SAVE** when you are done." After the tone, speak towards the microphone.
4. Press **SAVE** when done. The answering system automatically plays back the newly recorded announcement, then returns to the previous menu. During the playback, you can press **STOP** to stop or press **RECORD** to record again.

-OR-

Press **BACK** to return to the previous menu.

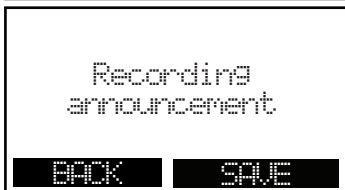
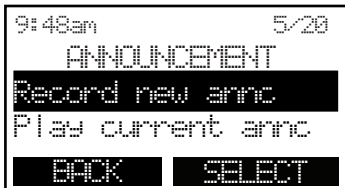
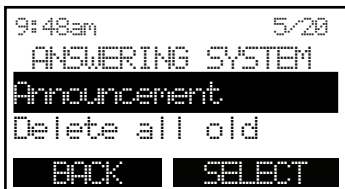

Answering system settings

Play your announcement

To play your announcement with a cordless handset:

1. Press **MENU** when the handset is not in use.
2. Press **▼** or **▲** to scroll to **Answering sys**, then press **SELECT**.
3. Press **SELECT** again to select **Announcement**.
4. Press **▼** or **▲** to scroll to **Play annc**, then press **SELECT**.

Options during playback:

- Press **VOL+** or **VOL-** to adjust the announcement playback volume.
- Press **5** or **OFF** to stop the playback.
- Press **⏸** to switch between the handset speakerphone and the handset earpiece.
- Press **DELETE** to delete the current announcement. The screen displays **Annc. Deleted**. The system announces, *“Announcement deleted.”*

To play your announcement with the telephone base:

1. Press **MENU** when the telephone base is not in use, then press **SELECT** to select **Answering system**.
2. Press **SELECT** again to select **Announcement**.
3. Press **▼** or **▲** to scroll to **Play current annc**, then press **SELECT**.

Options during playback:

- Press **▼VOL** or **▲VOL** to adjust the announcement playback volume.
- Press **STOP** to stop playback.
- Press **RECORD** to record a new announcement.
- Press **X/DELETE** to delete the current announcement. The screen displays **Annc. Deleted**. The system announces, *“Announcement deleted.”*



note

When your announcement is deleted, calls are answered with the preset announcement.

Answering system settings

Answer on/off

The answering system must be turned on to answer and record messages.

When the answering system is turned on, the **ANS**  light on the telephone base turns on. **ANS ON** displays on the handset and  displays on the telephone base.

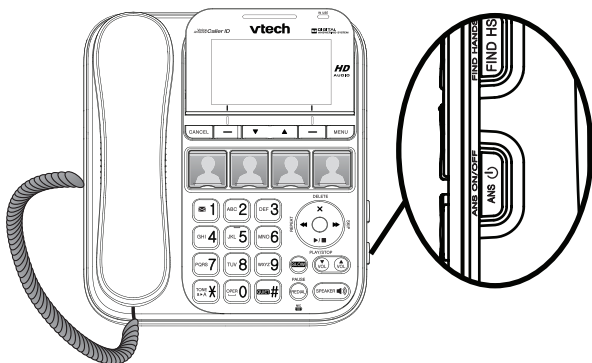

On the telephone base, press

ANS  to turn the answering system on or off.

When the answering system is turned on, the base displays **Calls will be answered** and announces, *“Calls will be answered.”* When the answering system is turned off, the base displays **Calls will not be answered** and announces, *“Calls will not be answered.”*

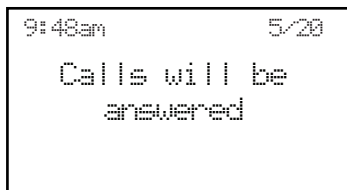

To set answer on/off with a cordless handset:

1. Press **MENU** when the handset is not in use.
2. Press **▼** or **▲** to scroll to **Answering sys**, then press **SELECT**.
3. Press **▼** or **▲** to scroll to **Answer ON/OFF**, then press **SELECT**.
4. Press **▼** or **▲** to scroll to **On** or **Off**, then press **SELECT**. You hear a confirmation tone.

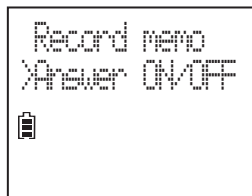

Answering system settings

Answer on/off

To set answer on/off with the telephone base:

- Press **ANS**  to turn the answering system on or off.

-OR-

1. Press **MENU** when the telephone base is not in use, then press **SELECT** to select **Answering system**.
2. Press **▼** or **▲** to scroll to **Answer ON/OFF**, then press **SELECT**.
3. Press **▼** or **▲** to scroll to **On** or **Off**, then press **SAVE**. You hear a confirmation tone.

note

- You cannot turn on the answering system with no memory capacity left. If you try to turn it on, the telephone announces, *"Memory is full. Calls will not be answered."*
- If the memory capacity is less than 3 minutes, the telephone announces, *"Less than three minutes to record,"* and the screen displays **Less than 3 min to record**.

Answering system settings

Call screening

Use this feature to choose whether incoming messages can be heard over the cordless handset or the telephone base while they are being recorded.

To set call screening on/off with a cordless handset:

1. Press **MENU** when the handset is not in use.
2. Press ▼ or ▲ to scroll to **Answering sys**, then press **SELECT**.
3. Press ▼ or ▲ to scroll to **Ans sys setup**, then press **SELECT**.
4. Press **SELECT** again to select **Call screening**.
5. Press ▼ or ▲ to scroll to **On** or **Off**, then press **SELECT**. You hear a confirmation tone.

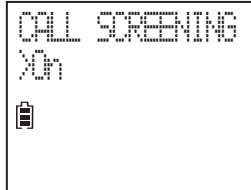
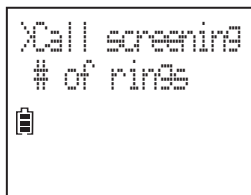

To set call screening on/off with the telephone base:

1. Press **MENU** when the telephone base is not in use, then press **SELECT** to select **Answering system**.
2. Press ▼ or ▲ to scroll to **Ans sys setup**, then press **SELECT**.
3. Press **SELECT** again to select **Call screening**.
4. Press ▼ or ▲ to scroll to **On** or **Off**, then press **SAVE**. You hear a confirmation tone.

Answering system settings

Number of rings

You can set the answering system to answer an incoming call after two, three, four, five or six rings; or toll saver. With toll saver selected, the answering system answers after two rings when you have new messages, or after four rings when there are no new messages. This enables you to check for new messages and avoid paying long distance charges when calling from out of your local area.

To set number of rings with a cordless handset:

1. Press **MENU** when the handset is not in use.
2. Press ▼ or ▲ to scroll to **Answering sys**, then press **SELECT**.
3. Press ▼ or ▲ to scroll to **Ans sys setup**, then press **SELECT**.
4. Press ▼ or ▲ to scroll to **# of rings**, then press **SELECT**.
5. Press ▼ or ▲ to scroll to select **6, 5, 4, 3, 2** or **Toll saver**, then press **SELECT**. You hear a confirmation tone.

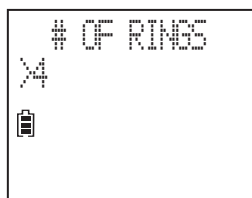
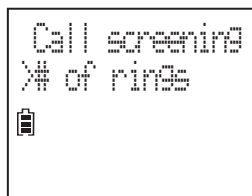

To set number of rings with the telephone base:

1. Press **MENU** when the telephone base is not in use, then press **SELECT** to select **Answering system**.
2. Press ▼ or ▲ to scroll to **Ans sys setup**, then press **SELECT**.
3. Press ▼ or ▲ to scroll to **# of rings**, then press **SELECT**.
4. Press ▼ or ▲ to scroll to select **6, 5, 4, 3, 2** or **Toll saver**, then press **SAVE**. You hear a confirmation tone.

Answering system settings

Remote access code

A two-digit security code is required to access the answering system remotely from any touch-tone telephone. The preset code is **19**. You can set the code from **00** to **99**.

To set remote access code with a cordless handset:

1. Press **MENU** when the handset is not in use.
2. Press **▼** or **▲** to scroll to **Answering sys**, then press **SELECT**.
3. Press **▼** or **▲** to scroll to **Ans sys setup**, then press **SELECT**.
4. Press **▼** or **▲** to scroll to **Remote code**, then press **SELECT**.
5. Press **▼** or **▲** to move the cursor to the left or right. Use the dialing keys (**0-9**) to enter a two-digit number.
6. Press **SELECT**. You hear a confirmation tone.

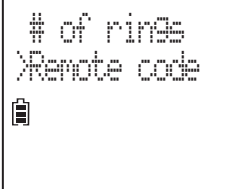

of rings
>Remote code
[phone icon]



REMOTE CODE
19
[phone icon]

To set remote access code with the telephone base:

1. Press **MENU** when the telephone base is not in use, then press **SELECT** to select **Answering system**.
2. Press **▼** or **▲** to scroll to **Ans sys setup**, then press **SELECT**.
3. Press **▼** or **▲** to scroll to **Remote code**, then press **SELECT**.
4. Press **▼** or **▲** to move the cursor to the left or right. Use the dialing keys (**0-9**) to enter a two-digit number.
5. Press **SAVE**. You hear a confirmation tone.

Answering system settings

Message alert tone

When the message alert tone is set to **On**, and there is at least one new message, the telephone base beeps every 10 seconds. The message alert tone is preset to **Off**.

There is no audible alert at the handset.

To set message alert tone with a cordless handset:

1. Press **MENU** when the handset is not in use.
2. Press ▼ or ▲ to scroll to **Answering sys**, then press **SELECT**.
3. Press ▼ or ▲ to scroll to **Ans sys setup**, then press **SELECT**.
4. Press ▼ or ▲ to scroll to **Msg alert tone**, then press **SELECT**.
5. Press ▼ or ▲ to scroll to **On** or **Off**, then press **SELECT**. You hear a confirmation tone.

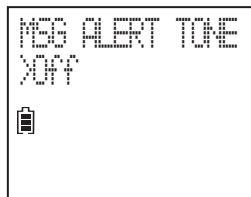
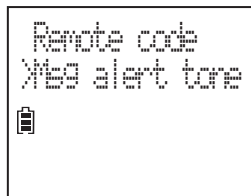

To set message alert tone with the telephone base:

1. Press **MENU** when the telephone base is not in use, then press **SELECT** to select **Answering system**.
2. Press ▼ or ▲ to scroll to **Ans sys setup**, then press **SELECT**.
3. Press ▼ or ▲ to scroll to **Msg alert tone**, then press **SELECT**.
4. Press ▼ or ▲ to scroll to **On** or **Off**, then press **SAVE**. You hear a confirmation tone.

note

The answering system must be turned on for the message alert tone feature to be functional.

Answering system settings

Message recording time

You can set the recording time allowed for incoming messages. The message length is three minutes by default.

To set message recording time with a cordless handset:

1. Press **MENU** when the handset is not in use.
2. Press ▼ or ▲ to scroll to **Answering sys**, then press **SELECT**.
3. Press ▼ or ▲ to scroll to **Ans sys setup**, then press **SELECT**.
4. Press ▼ or ▲ to scroll to **Recording time**, then press **SELECT**.
5. Press ▼ or ▲ to scroll to **3 minutes**, **2 minutes** or **1 minute**, then press **SELECT**. You hear a confirmation tone.

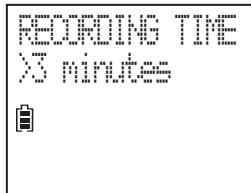
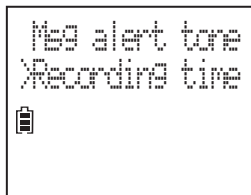

To set message recording time with the telephone base:

1. Press **MENU** when the telephone base is not in use, then press **SELECT** to select **Answering system**.
2. Press ▼ or ▲ to scroll to **Ans sys setup**, then press **SELECT**.
3. Press ▼ or ▲ to scroll to **Recording time**, then press **SELECT**.
4. Press ▼ or ▲ to scroll to **3 minutes**, **2 minutes** or **1 minute**, then press **SAVE**. You hear a confirmation tone.

Answering system operation

Answering system and voicemail

Your telephone has separate indicators for two different types of voice messages: those left on its built-in digital answering system and those left with your telephone service provider's voicemail (fees may apply). Your telephone's built-in digital answering system messages and voicemail messages are separate. Each alerts you to new messages differently.

- If ►/■/PLAY/STOP on the telephone base flashes, **XX New messages** displays on the cordless handsets and telephone base, there are new messages in the built-in answering system. To listen to the messages recorded on your digital answering system, press **MENU** twice on a handset, or press ►/■/PLAY/STOP on the telephone base.
- If ✉ and **New voicemail** display on the cordless handsets, and ✉ and **New voicemail** display on the telephone base, your telephone service provider is indicating that it has new voicemail for you. To listen to your voicemail, press and hold ✉ **1** on your handset/telephone base. See **Voicemail number** on page 40 to set your voicemail number.

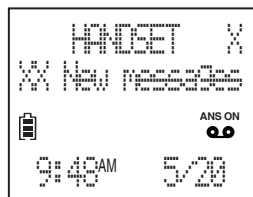

Some telephone service providers bundle or combine multiple services like voicemail and call waiting, so you may not be aware that you have voicemail. To check what services you have and how to access them, contact your telephone service provider.

To use your voicemail service rather than your answering system, turn off your answering system. To use your answering system rather than your voicemail service, contact your telephone service provider to deactivate your voicemail service.

Answering system operation

Using the answering system and voicemail together

You can also use your telephone answering system and voicemail together by setting your built-in answering system to answer before voicemail answers as described below. To learn how to program your voicemail settings, contact your telephone service provider. Then, if you are on a call, or if the answering system is busy recording a message and you receive another call, the second caller can leave a voicemail message.

Set your answering system to answer calls at least two rings earlier than your voicemail is set to answer. For example, if your voicemail answers after six rings, set your answering system to answer after four rings. Some voicemail providers may program the delay before answering calls in seconds instead of rings. In this case, allow six seconds per ring when determining the appropriate setting.

Message capacity

The answering system can record and store up to 99 messages. Each message can be up to three minutes in length. The total storage capacity for the announcement, messages, memos and reminders is approximately 14 minutes. The actual recording time depends on individual message characteristics. Messages remain available for replay until you delete them.

Answering system operation

New message indication

The ►/■/PLAY/STOP light on the telephone base flashes, and **XX New messages** displays on the handset and telephone base when there are new answering system messages.

If the message alert tone is turned on, the telephone base beeps every 10 seconds when there are messages that have not been reviewed.

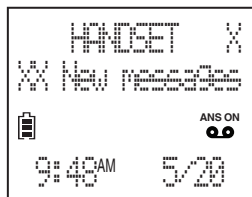

Call screening

To screen a call at the telephone base:

If the answering system and call screening are on, the announcement and the incoming message broadcast at the telephone base while the call is answered by the answering system.

Options while a message is being recorded:

- Press ▼VOL or ▲VOL to adjust the listening volume.
- Press ►/■/STOP to temporarily turn off the feature.
- Press **SILENCE** to temporarily mute the feature.
- Press **SCREEN** to temporarily turn on the feature if it is set to off.

To screen a call at a cordless handset:



If the answering system and call screening are on, press **SELECT**. The announcement and the incoming message broadcast at the handset while the call is answered by the answering system.

Options while a message is being recorded:

- Press VOL+ or VOL- to adjust the listening volume.
- Press OFF to temporarily turn off the feature.
- Press **SELECT** to temporarily turn on the feature if it is set to off.

Answering system operation

Call intercept

If you want to talk to the caller whose message is being recorded, press  or  on a cordless handset, or **SPEAKER**  on the telephone base, or lift the corded handset from the telephone base.

Temporarily turn off the message alert tone

If the message alert tone is turned on (see page 107), the telephone base beeps every 10 seconds when there are new messages. Pressing any telephone base key (except **FIND HS**) temporarily silences the message alert tone.

The message alert tone resumes when you receive a new message.

Answering system operation

Message playback

When playback begins, the total number of old or new messages is announced. Before each message, you hear the day and time of the recording. If the date and time are not set, you hear, “*Time and date not set,*” before playback. After the last message, you hear, “*End of messages.*” If the recording time is less than three minutes, you hear, “*Less than three minutes to record.*” If there is no remaining recording time, you hear “*Memory is full.*” If there are no recorded messages, the screen shows **No messages** and you hear, “*You have no messages.*”

To play messages on a cordless handset:

1. Press **MENU** when the handset is not in use.
2. Press **SELECT** to select **Play messages**.
3. If you have only new or old messages, the messages play automatically.

-OR-

If you have both new and old messages, press ▼ or ▲ to scroll to **Play new msgs** or **Play old msgs**, then press **SELECT**.

Options during playback:

- Press **VOL+** or **VOL-** to adjust the message playback volume.
- Press **6** to skip to the next message.
- Press **4** to repeat the message. Press **4** twice to hear the previous message.
- Press **DELETE** to delete the playing message. The screen displays **Message deleted**. The system announces, “*Message deleted,*” and then advances to the next message.
- Press **⏸** to switch between the handset speakerphone and the handset earpiece.
- Press **TALK** to call back the caller. The screen displays **Call back?** Press **SELECT** to confirm or press **OFF** to cancel.
- Press **SELECT** to pause the playback and view the caller’s information. Then you can press **TALK** or **⏸** to call back.

Answering system operation

Message playback

To play messages at the telephone base:

1. Press **PLAY** when the telephone base is not in use.
2. If you have only new or old messages, the messages play automatically.

-OR-

If you have both new and old messages, press ▼ or ▲ to scroll to **Play new msgs** or **Play old msgs**, then press **SELECT**.

Options during playback:

- Press ▼**VOL** or ▲**VOL** to adjust the message playback volume.
- Press ►/■/**SKIP** to skip to the next message.
- Press ◀/■/**REPEAT** to repeat the message. Press ◀/■/**REPEAT** twice to hear the previous message.
- Press X/**DELETE** to delete the playing message. The screen displays **Message deleted**. The system announces, “*Message deleted,*” and then advances to the next message.
- Press ►/■/**STOP** to stop the playback.
- Press **SLOW** to reduce the playback speed.
- Press **CALL BACK** to call back the caller. The screen displays **Call back?** Press **YES** to confirm or **NO** to cancel.

To play messages at a pendant:

- Use the voice command feature (see page 120).

Answering system operation

Delete all old messages

You can only delete old (reviewed) messages. **No old messages to delete** displays when you have no old messages. You cannot delete new messages until you review them. You cannot retrieve deleted messages.

To delete all old messages with a cordless handset:

1. Press **MENU** when the handset is not in use.
2. Press ▼ or ▲ to scroll to **Answering sys**, then press **SELECT**.
3. Press ▼ or ▲ to scroll to **Delete all old**, then press **SELECT**. The screen displays **Delete all old messages?**
4. Press **SELECT** to confirm. The screen displays **Deleting...** then **All old msgs deleted!** You hear a confirmation tone.

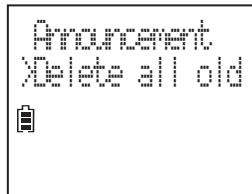

To delete all old messages with the telephone base:

1. Press **MENU** when the telephone base is not in use, then press **SELECT** to select **Answering system**.
 2. Press ▼ or ▲ to scroll to **Delete all old**, then press **SELECT**. The screens displays **Delete all old messages?**
 3. Press **YES** to confirm. The screen displays **Deleting...** then **All old msgs deleted!** You hear a confirmation tone.
- OR-**
1. Press **X/DELETE** when the telephone base is not in use.
 2. Quickly press **X/DELETE** again. The screen displays **Deleting...** then **All old msgs deleted!** You hear a confirmation tone.

Answering system operation

Record, play and delete memos

Memos are your own recorded messages used as reminders for yourself or others using the same answering system. You can record your own memos using a system handset or the telephone base. Play and delete them in the same way as incoming messages (see **Message playback** on pages 113 and 114).

To record a memo with a cordless handset:

1. Press **MENU** when the handset is not in use.
2. Press ▼ or ▲ to scroll to **Answering sys**, then press **SELECT**.
3. Press ▼ or ▲ to scroll to **Record memo**, then press **SELECT**.
4. The system announces, *“Record after the tone. Press 5 when you are done.”* After the tone, speak towards the microphone.
5. Press **5** when done. The system announces, *“Recorded.”*

To record a memo with the telephone base:

1. Press **MENU** when the telephone base is not in use, then press **SELECT** to select **Answering system**.
2. Press ▼ or ▲ to scroll to **Record memo**, then press **SELECT**.
3. The system announces, *“Record after the tone. Press **SAVE** when you are done.”* After the tone, speak towards the microphone.
4. Press **SAVE** when done. The system announces, *“Recorded.”*

note

- *“Memory is full,”* is announced if you record a memo when the memory is full.
- Each memo can be up to three minutes in length.
- Memos shorter than two seconds are not recorded.

Answering system operation

Remote access

A two-digit security code is required to access the answering system remotely from any touch-tone telephone. The preset code is **19**. See **Remote access code** on page 106 to change it.

1. Dial your telephone number from any touch-tone telephone.
2. Enter the two-digit security code after the announcement and the long beep.
3. The system announces, “*Press star for reminder or press pound to listen to messages.*” Press ^{TO}_{a>}A* or #.
 - After pressing ^{TO}_{a>}A*, you can enter one of the following remote commands:

Command	Function
1	Review reminders.
2	Set reminders.
3	End the call.
4	Turn reminder off.

Answering system operation

Remote access

-OR-

- After pressing #, you can enter one of the following remote commands.

Command	Function
1	Play all messages.
2	Play new messages.
3	Delete the current message (during playback).
33	Delete all old messages.
4	Repeat the current message (during playback).
5	Stop.
*5	Hear a list of remote commands.
6	Skip to the next message (during playback).
*7	Record a new announcement.
8	End the call.
0	Turn the answering system on or off.

note

- If you do not press any key within 20 seconds, the remote access call automatically disconnects.
- When the answering system memory is full, the telephone announces, *"Memory is full. Enter the remote access code."*
- When the answering system is off, the telephone answers after 10 rings, and announces, *"Please enter your remote access code."*

Voice command

About voice command

By saying certain commands to the pendant, you can hear information such as the date or time, or call photo speed dial numbers, or even review call log, messages or reminders.

Use voice command

Press **VOICE** on either side of the pendant when the telephone is not in use. After you hear a beep, say your command to the pendant.

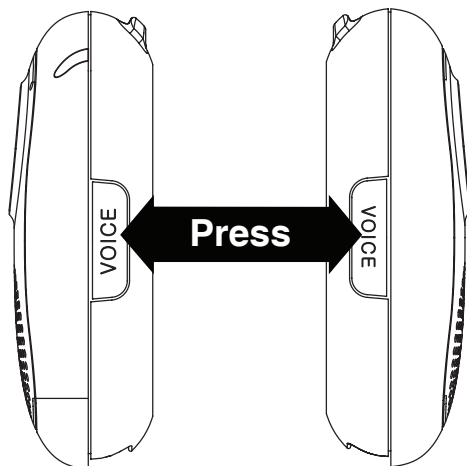

Common commands

"What can I say?" - To hear a list of voice commands.

"What time is it?" - To hear the current time.

"What is the date?" - To hear the current date.

"Call speed dial X." - To call a photo speed dial number.

"Intercom all." - To send out intercom request to all devices.

"Cancel." - To return to idle mode.

Voice command

Use voice command

Reminders

Press **VOICE** and say *“Review reminders.”* The system will automatically review all missed reminders. If you do not have any reminders, the system will announce *“You don’t have any reminders for today.”*

During the playback, press **VOICE** and say one of the following commands:

“What can I say?” - To hear a list of voice commands.

“Skip reminder.” - To skip to the next reminder.

“Repeat reminder.” - To repeat the reminder.

“Stop.” - To stop the reminder playback.

“Cancel.” - To continue the reminder playback.

Messages

Press **VOICE** and say *“Review messages.”*

During the playback, press **VOICE** and say one of the following commands:

“What can I say?” - To hear a list of voice commands.

“Skip message.” - To skip to the next message.

“Repeat message.” - To repeat the message.

“Slow playback.” - To slow down the message playback.

- To resume normal playback, press **VOICE** and say *“Play normal.”*

“Stop.” - To stop the message playback.

“Delete.” - To delete the current message.

“Cancel.” - To continue the message playback.

Voice command

Use voice command

Call log

Press **VOICE** and say *“Review call log.”*

During the playback, press **VOICE** and say one of the following commands:

“What can I say?” - To hear a list of voice commands.

“Skip call log.” - To skip to the next call log entry.

“Repeat call log.” - To repeat the call log entry.

“Stop.” - To stop the call log entry playback.

“Cancel.” - To continue the call log entry playback.

“Call back.” - The system will ask, *“Would you like to call XXX?”*

- Say *“Yes”* to call the number.
 - Say *“No”* to return to the playback.
-

note

If you do not say the command within five seconds, or the system does not understand your command, the system will say, *“Sorry, I didn’t catch that. Please press the voice command button and try again.”*

Appendix

Display screen messages

BASE 0 is calling	The telephone base is calling the handset.
Caller ID log empty	There are no entries in caller ID log history.
Calling all devices	The handset or telephone base is calling all devices (for intercom calls).
Calling BASE 0	The handset is calling the base (for intercom calls). The handset is transferring an outside call to the base.
Calling HANDSET X	The handset or telephone base is calling another handset (for intercom calls). The handset or telephone base is transferring an outside call to another handset.
Calls will be answered	The answering system is turned on and will answer calls.
Calls will not be answered	The answering system is turned off and will not answer calls.
Check AC Power	The telephone base is on a call while AC power is not available.
Contact deleted	A phonebook entry is deleted.
Ended	You have just ended a call.
HANDSET X is calling	Another system handset is calling (for intercom calls).
Incoming call	There is a call coming in.
Intercom	The handset/telephone base is on an intercom call.
Intercom ended	The intercom call has just ended.

Appendix

Display screen messages

INTERCOM TO:	You have started the intercom process, and need to enter the number of the device you wish to call.
Less than 3 min	The answering system recording time is less than three minutes.
Line in use	An extension phone, or one of the handsets or the telephone base is in use.
Low battery	The handset battery needs to be recharged.
Microphone ON	The mute function is turned off and the other party can hear you.
Missed Reminder	There are reminders that have not been reviewed.
Muted	The mute function is turned on. The other party cannot hear you but you can hear the other party.
Memory full	The answering system has no remaining recording time.
New voicemail	There are new voicemail messages from your telephone service provider.
No answer. Try again.	When you send out an intercom request, the destination device is in use, out of range, not powered, or does not answer within 100 seconds. When you send out a transfer request, the destination device is in use, out of range or not powered.
No battery	The handset in the handset charger has no battery installed.
No line	There is no telephone line connected.
Not available at this time	Someone else is already accessing the phonebook, caller ID log or answering system.

Appendix

Display screen messages

No response to transfer	When you send out a transfer request, the destination device does not answer within 30 seconds.
Number already saved	The telephone number you try to save is already in the phonebook.
Out of range OR Base no Power	The telephone base has lost power, or the handset is out of range.
Paging all devices	The telephone base is paging all devices.
Phone	The handset is on a call.
Phonebook empty	There are no phonebook entries.
Phonebook full	The phonebook is full. You cannot save any new entries unless you delete some current entries.
Place in charger	The battery is very low. The handset should be charged.
Quiet mode is off	The quiet mode is off.
Quiet mode on	The quiet mode is on.
Rec mem full	The system recording time is full.
Rec mem low	The system recording time is low.
Recording...	The answering system is recording a message.
Registered	The handset is registered to the telephone base.

Appendix

Display screen messages

Registration failed	The registration is not successful.
Registering... Please wait	The handset or the pendant registration is in progress.
Reminder is turned ON	The reminder is automatically set to on.
Ringer muted	The ringer is muted temporarily while the device is ringing.
Ringer off	The ringer is off temporarily during an incoming call.
Saved	Your selection has been saved.
Speaker	The handset or telephone base speakerphone is in use.
To register HS, see manual	Screen display on a non-registered handset.
To screen call, press [SELECT]	The system is recording a message. Press SELECT to screen a call on a handset.
Transferred	You have transferred an outside call to another cordless handset or the telephone base.
You don't have any reminders	There is no reminder in the telephone system.
XX Missed calls	There are new calls in the caller ID log.
XX New messages	There are new messages.
XX New reminders	There are new reminders.
** Paging **	The handset is being paged by the telephone base.



Appendix

Handset, telephone base and pendant indicators

Handset lights

Visual ringer indicator	Flashes when the handset is ringing.
	On when the handset speakerphone is in use.
CHARGE	On when the handset is charging in the handset charger.

Telephone base lights

Visual ringer indicator	Flashes when the telephone base is ringing.
IN USE	On when the telephone line is in use. On when the answering system is answering a call. On when you are registering a handset or pendant. Flashes when another telephone sharing the same line is in use. Flashes when you are deregistering all devices.
ANS 	On when the answering system is turned on.
SPEAKER 	On when the speakerphone is in use.
 /PLAY/STOP	Flashes when there are new memos or messages in the answering system.

Appendix

Handset, telephone base and pendant indicators









Pendant lights

Pendant status light	Stays solid red when the pendant is charging. Flashes red when the pendant is in low battery. Stays solid green when the pendant is fully charged. Flashes red and green when the base is paging the pendant. Flashes quickly in red and green during pendant registration. Flashes orange three times when the pendant is not registered.
Pendant light (ring around ↷)	On steady when the pendant is in use. Flashes quickly when there is an incoming call. Flashes twice every three seconds when another telephone system device is in use.





Appendix

Handset, telephone base and pendant indicators

Handset icons

	The battery icon flashes when the battery is low and needs charging.
	The battery icon animates when the battery is charging.
	The battery icon becomes solid when the battery is fully charged.
	On when the handset speakerphone is in use.
	The handset ringer is off.
	There are new voicemail received from your telephone service provider.
ANS ON	The answering system is turned on.
	There are new messages in the answering system.
NEW	The caller ID log entry you are reviewing is new. The message you are listening is new.
MUTE	The handset microphone is muted.
AUDIO ASSIST	The handset Audio Assist® feature is on.
	The number of the current message and the total number of messages recorded.

Telephone base icons

	The telephone base ringer is off.
	There are new voicemail received from your telephone service provider.
NEW	The caller ID log entry you are reviewing is new. The message you are listening is new.
	The telephone base Audio Assist® feature is on.
ANS 	The answering system is turned on.
MUTE	The telephone base microphone is muted.

Appendix

Handset battery

It takes up to 11 hours for the battery to be fully charged. When it is fully charged, you can expect the following performance:

Operation	Operating time
While in handset use (talking*)	Up to seven hours
While in speakerphone mode (talking*)	Up to five hours
While not in use (standby**)	Up to seven days

* Operating times vary depending on your actual use and the age of the battery.

** Handset is not charging or in use.

The battery needs charging when:

- A new battery is installed in the handset.
- The handset beeps.
- A battery is properly installed and the screen is blank.
- **Low battery** or **Place in charger** displays on the handset screen.

CAUTION:

To reduce the risk of fire or injury, read and follow these instructions:

- Use only the batteries provided or equivalent. To order a replacement, go to **www.vtechphones.com** or call **1 (800) 595-9511**. In Canada, go to **www.vtechcanada.com** or dial **1 (800) 267-7377**.
- Do not dispose of the batteries in a fire. Check with local waste management codes for special disposal instructions.
- Do not open or mutilate the batteries. Released electrolyte is corrosive and may cause burns or injury to the eyes or skin. The electrolyte may be toxic if swallowed.
- Exercise care in handling batteries in order not to create a short circuit with conductive materials.
- Charge the batteries provided with or identified for use with this product only in accordance with the instructions and limitations specified in this manual.
- Observe proper polarity orientation between the battery and metallic contacts.
- To prevent fire or shock hazard, do not expose this product to water or any type of moisture.

Appendix

Pendant battery

It takes up to three hours for the battery to be fully charged. When it is fully charged, you can expect the following performance:

Operation	Operating time
While in speakerphone mode (talking*)	Up to five hours

* Operating time varies depending on your actual use and the age of the battery.

The battery needs charging when:

- You hear “*Low battery.*”
- There is an alert tone every one minute.
- The pendant status light flashes red or is solid red.

Conserve battery life:

The pendant battery is not replaceable.

If the pendant will not be used for a long period of time, switch **OFF** the pendant to conserve pendant battery life.

CAUTION:

To prevent fire or shock hazard, do not expose this product to water or any type of moisture.

Appendix

Troubleshooting

If you have difficulty with your telephone, please try the suggestions below. For customer service, visit our website at www.vtechphones.com or call **1 (800) 595-9511**. In Canada, go to www.vtechcanada.com or dial **1 (800) 267-7377**.

My telephone doesn't work at all.

- Make sure the power cord is securely plugged in.
- If there are backup batteries in the telephone base, make sure they are correctly installed.
- Make sure you plug the battery connector securely into the cordless handset.
- Make sure you plug the telephone line cord securely and firmly into the telephone base and the telephone wall jack.
- Charge the battery in the cordless handset for at least 11 hours. For optimum daily performance, return the cordless handset to the handset charger when not in use.
- Charge the pendant for at least 3 hours. For optimum daily performance, return the pendant to the pendant charger when not in use.
- Make sure you turn the pendant on before use.
- If the battery is completely depleted, charge the handset or the pendant for at least 30 minutes before use.
- Reset the telephone base. Unplug the electrical power. Take out the backup batteries if necessary. Wait for approximately 15 seconds, then plug it back in. Allow up to one minute for the cordless handset, pendant and telephone base to reset.
- You may need to purchase a new handset battery.

I cannot get a dial tone.

- Try all the suggestions above.
- Move the cordless handset or the pendant closer to the telephone base. You may have moved out of range.
- If the previous suggestions do not work, disconnect the telephone base from the telephone jack and connect to a different phone. If there is no dial tone on that phone either, the problem is in your wiring or telephone service. Contact your telephone service provider.
- Your line cord may be defective. Try installing a new line cord.

Appendix

Troubleshooting

I cannot dial out.

- Try all the suggestions above.
- Make sure you have a dial tone before dialing. The cordless handset or the pendant may take a second or two to find the telephone base and produce a dial tone. This is normal. Wait an extra second before dialing.
- Eliminate any background noise. Noise from a television, radio or other appliances might cause the phone to not dial out properly. If you cannot eliminate the background noise, first try muting the cordless handset before dialing, or dial from another room with less background noise.
- If other phones in your home are having the same problem, contact your telephone service provider (charges may apply).
- If you have changed your telephone service to digital service from a cable company or a VoIP service provider, the telephone line may need to be rewired to allow all existing telephone jacks to work. Contact your service provider for more information.

My cordless handset/pendant isn't performing normally.

- Make sure you plug the power cord securely into the telephone base. Plug the power adapter into a different, working electrical outlet without a wall switch.
- Move the cordless handset or the pendant closer to the telephone base. You may have moved out of range.
- Reset the telephone base. Unplug the electrical power. Take out the backup batteries if necessary. Wait for 15 seconds then plug the power cord back in, and reinstall the backup batteries. Allow up to one minute for the cordless handset/pendant and telephone base to reset.
- Other electronic products such as HAM radios and other DECT phones can cause interference with your cordless phone. Try installing your phone as far away as possible from these types of electronic devices.

Appendix

Troubleshooting

Out of range OR Base no power appears on my cordless handset.

- Ensure you plug the telephone base in properly and the power is on.
- Place the cordless handset closer to the telephone base for synchronization.
- Move the cordless handset closer to the telephone base. You may have moved out of range.
- Reset the telephone base. Unplug the electrical power. Wait for 15 seconds then plug it back in. Allow up to one minute for the cordless handset and telephone base to reset.
- Other electronic products such as HAM radios and other DECT phones can cause interference with your cordless phone. Try installing your phone as far away as possible from these types of electronic devices.

The handset battery does not accept charge while in the handset charger.

- If the cordless handset is in the handset charger and the charge light is not on, refer to **The charge light is off** on page 136.
- Charge the battery in the cordless handset for at least 11 hours. For optimum daily performance, return the cordless handset to the handset charger when not in use.
- If the battery is completely depleted, charge the handset for at least 30 minutes before use.
- You may need to purchase a new battery.

The pendant battery does not accept charge while in the pendant charger.

- If the pendant is in the pendant charger and the pendant status light is not on, refer to **The charge light is off** on page 136.
- Charge the battery in the pendant for at least 3 hours. For optimum daily performance, return the pendant to the pendant charger when not in use.
- If the battery is completely depleted, charge the pendant for at least 30 minutes before use.

Appendix

Troubleshooting

I have accidentally set my cordless handset/telephone base LCD language to Spanish or French, and I don't know how to change it back to English.

- Press **MENU**, then enter the code TO NE 8 * A ***364#**.

I get noise, static, or weak signals even when I'm near the telephone base.

- If you subscribe to high-speed Internet service (DSL - digital subscriber line) through your telephone line, you must install a DSL filter between the telephone line cord and the telephone wall jack. The filter prevents noise and caller ID problems as a result of DSL interference. Contact your DSL service provider for more information about DSL filters.
- You may be able to improve the performance of your cordless phone by installing your new telephone base as far as possible from any other existing cordless telephone system that may already be installed.
- Other electronic products such as HAM radios and other DECT phones can cause interference with your cordless phone. Try installing your phone as far away as possible from these types of electronic devices.
- Do not install this phone near a microwave oven or on the same electrical outlet. You may experience decreased performance while the microwave oven is operating.
- If you plug your phone in with a modem or a surge protector, plug the phone (or modem/surge protector) into a different location. If this does not solve the problem, relocate your phone or modem farther apart from one another, or use a different surge protector.
- Relocate your phone to a higher location. The phone may have better reception in a high area.
- If other phones in your home are having the same problem, contact your telephone service provider (charges may apply).

I experience poor sound quality when using the handset speakerphone.

- For increased sound quality while using the handset speakerphone, place the handset on a flat surface with the dialing keys facing up.

Appendix

Troubleshooting

I hear other calls while using my phone.

- Disconnect the telephone base from the telephone jack, and plug in a different telephone. If you still hear other calls, call your telephone service provider.

The telephone does not ring when there is an incoming call.

- Make sure that the ringer is not off.
- Make sure you plug in the telephone line cord securely into the telephone base and the telephone jack.
- Make sure you plug in the power cord securely.
- Make sure the backup batteries are correctly installed if necessary.
- The cordless handset/pendant may be too far from the telephone base.
- Charge the battery in the cordless handset for at least 11 hours. For optimum daily performance, return the cordless handset to the handset charger when not in use.
- Charge the pendant for at least three hours. For optimum daily performance, return the pendant to the pendant charger when not in use.
- You may have too many extension phones on your telephone line to allow all of them to ring simultaneously. Try unplugging some of the other phones.
- The layout of your home might be limiting the operating range. Try moving the telephone base to another location, preferably to a higher location.
- If other phones in your home are having the same problem, contact your telephone service provider (charges may apply).
- Test a working phone at the phone jack. If another phone has the same problem, contact your telephone service provider (charges may apply).
- Other electronic products such as HAM radios and other DECT phones can cause interference with your cordless phone. Try installing your phone as far away as possible from these types of electronic devices.
- Remove and install the cordless handset battery again. Place the cordless handset in the handset charger. Wait for the cordless handset to reestablish its connection with the telephone base. Allow up to one minute for this to take place.
- Your line cord may be defective. Try installing a new line cord.

Appendix

Troubleshooting

My calls cut in and out while I'm using my cordless handset/pendant.

- Other electronic products such as HAM radios and other DECT phones can cause interference with your cordless phone. Try installing your phone as far away as possible from these types of electronic devices.
- Do not install this phone near a microwave oven or on the same electrical outlet. You may experience decreased performance while the microwave oven is operating.
- If you plug your phone in with a modem or surge protector, plug the phone (or modem/surge protector) into a different location. If this does not solve the problem, relocate your phone or modem farther apart from one another, or use a different surge protector.
- Relocate your telephone base to a higher location. The phone may have better reception when installed in a high area.
- If other phones in your home are having the same problem, contact your telephone service provider (charges may apply).

The charge light is off.

- Make sure you plug the power and line cords in correctly and securely.
- Reset the telephone base. Unplug the electrical power. Take out the backup batteries if necessary. Wait for 15 seconds then plug the power cord back in, and reinstall the backup batteries. Allow up to one minute for the cordless handset/pendant and telephone base to reset.
- Clean the charging contacts on the cordless handset/pendant and the handset/pendant charger each month with a pencil eraser or cloth.
- Make sure that the handset battery is installed properly.

Appendix

Troubleshooting

My caller ID isn't working properly.

- Caller ID is a subscription service. You must subscribe to this service from your telephone service provider for this feature to work on your phone.
- The caller must be calling from an area that supports caller ID.
- Both your and your caller's telephone service providers must use caller ID compatible equipment.
- If you subscribe to high-speed Internet service (DSL - digital subscriber line) through your telephone line, you must install a DSL filter between the telephone line cord and the telephone wall jack. The filter prevents noise and caller ID problems resulting from DSL interference. Contact your DSL service provider for more information about DSL filters.

My telephone does not receive caller ID when on a call.

- Make sure you subscribe to caller ID with call waiting features from your telephone service provider. Caller ID feature works only if both you and the caller are in areas offering caller ID service, and if both telephone service providers use compatible equipment.

The messages on the answering system are incomplete.

- If a caller leaves a very long message, part of it may be lost when the answering system disconnects the call after the preset recording time.
- If the caller pauses for too long, the answering system stops recording and disconnects the call.
- If memory on the answering system becomes full during a message, the answering system stops recording and disconnects the call.
- If the caller's voice is very soft, the answering system may stop recording and disconnect the call.

The messages are very difficult to hear.

- Press **▲VOL** on the telephone base, or **VOL+** on the cordless handset, or **VOL+** on the pendant to increase the listening volume.

Appendix

Troubleshooting

The answering system does not answer after the correct number of rings.

- Make sure that the answering system is on. **ANS ON** should be shown on all handsets and the telephone base, and the **ANS**  light on the telephone base should be on.
- If toll saver is activated, the number of rings changes to two when you have new messages stored.
- If the memory is full or the system is off, the system will answer after 10 rings.
- In some cases, the answering system is affected by the ringing system used by your telephone service provider.
- If you subscribe to voicemail service, change the number of rings so that your answering system answers before your voicemail answers. To determine how many rings activate your voicemail, contact your telephone service provider.
- If there is a fax machine connected to the same telephone line, try disconnecting the fax machine. If that solves the problem, consult your fax machine documentation for information on compatibility with answering systems.

The telephone does not respond to remote commands.

- Make sure you enter your remote access code correctly.
- Make sure you are calling from a touch-tone phone. When you dial a number, you should hear tones. If you hear clicks, the phone is not a touch-tone telephone and cannot activate the answering system.
- The answering system may not detect the remote access code while your announcement is playing. Try waiting until the announcement is over before entering the code.
- There may be interference on the phone line you are using. Press dialing keys firmly.

Appendix

Troubleshooting

The answering system does not record messages.

- Make sure that the answering system is on. **ANS ON** should be shown on all handsets and the telephone base, and the **ANS**  light on the telephone base should be on.
- Make sure the memory of the answering system is not full.
- If you subscribe to voicemail service, change the number of rings so that your answering system answers before your voicemail answers. To determine how many rings activate your voicemail, contact your telephone service provider.
- If there is a fax machine connected to the same telephone line, try disconnecting the fax machine. If that solves the problem, consult your fax machine documentation for information on compatibility with answering systems.



The system announces *“Time and day not set.”*

- You need to reset the system clock.

The outgoing announcement is not clear.

- When you record your announcement, make sure you speak in a normal tone of voice, about nine inches from the handset or telephone base.
- Make sure there is no background noise (TV, music, etc.) while recording.

New voicemail and show on the cordless handset and New voicemail and show on the telephone base and I don't know why.

- Your telephone has both a built-in answering system and voicemail indication. If **New voicemail** and  appear on the cordless handset, and **New voicemail** and  appear on the telephone base, then your telephone has received a signal from your telephone service provider that you have a voicemail message waiting for you to retrieve from them. Contact your telephone service provider for more information on how to access your voicemail.

Appendix

Troubleshooting

I cannot retrieve voicemail messages.

- Your telephone has both a built-in answering system and voicemail indication. They are independent features and each alerts you to new messages differently. If you subscribe to voicemail service from your telephone service provider, contact your telephone service provider for more information on how to access your voicemail.

Common cure for electronic equipment.

If the telephone does not seem to be responding normally, do the following (in the order listed):

- Disconnect the power to the telephone base.
- Remove the telephone base backup batteries.
- Disconnect the cordless handset battery.
- Wait a few minutes.
- Connect power to the telephone base.
- Install the telephone base backup batteries again.
- Install the cordless handset battery again, and place the cordless handset into the handset charger.
- Wait for the cordless handset and the pendant to reestablish their connections with the telephone base. Allow up to one minute for this to take place.

Appendix

Important safety instructions

When using your telephone equipment, basic safety precautions should always be followed to reduce the risk of fire, electric shock and injury, including the following:

1. Read and understand all instructions.
2. Follow all warnings and instructions marked on the product.
3. Unplug this product from the wall outlet before cleaning. Do not use liquid or aerosol cleaners. Use a damp cloth for cleaning.
4. Do not use this product near water such as near a bath tub, wash bowl, kitchen sink, laundry tub or swimming pool, or in a wet basement or shower.
5. Do not place this product on an unstable table, shelf, stand or other unstable surfaces.
6. Slots and openings in the back or bottom of the telephone base, handset and pendant are provided for ventilation. To protect them from overheating, these openings must not be blocked by placing the product on a soft surface such as a bed, sofa or rug. This product should never be placed near or over a radiator or heat register. This product should not be placed in any area where proper ventilation is not provided.
7. This product should be operated only from the type of power source indicated on the marking label. If you are not sure of the type of power supply in your home or office, consult your dealer or local power company.
8. Do not allow anything to rest on the power cord. Do not install this product where the cord may be walked on.
9. Never push objects of any kind into this product through the slots in the telephone base or handset because they may touch dangerous voltage points or create a short circuit. Never spill liquid of any kind on the product.
10. To reduce the risk of electric shock, do not disassemble this product, but take it to an authorized service facility. Opening or removing parts of the telephone base or handset other than specified access doors may expose you to dangerous voltages or other risks. Incorrect reassembling can cause electric shock when the product is subsequently used.
11. Do not overload wall outlets and extension cords.

Appendix

Important safety instructions

12. Unplug this product from the wall outlet and refer servicing to an authorized service facility under the following conditions:
 - When the power supply cord or plug is damaged or frayed.
 - If liquid has been spilled onto the product.
 - If the product has been exposed to rain or water.
 - If the product does not operate normally by following the operating instructions. Adjust only those controls that are covered by the operation instructions. Improper adjustment of other controls may result in damage and often requires extensive work by an authorized technician to restore the product to normal operation.
 - If the product has been dropped and the telephone base/handset/pendant has been damaged.
 - If the product exhibits a distinct change in performance.
13. Avoid using a telephone (other than cordless) during an electrical storm. There is a remote risk of electric shock from lightning.
14. Do not use the telephone to report a gas leak in the vicinity of the leak. Under certain circumstances, a spark may be created when the adapter is plugged into the power outlet, or when the handset or pendant is replaced in its cradle. This is a common event associated with the closing of any electrical circuit. The user should not plug the phone into a power outlet, and should not put a charged handset or pendant into its cradle, if the phone is located in an environment containing concentrations of flammable or flame-supporting gases, unless there is adequate ventilation. A spark in such an environment could create a fire or explosion. Such environments might include: medical use of oxygen without adequate ventilation; industrial gases (cleaning solvents; gasoline vapors; etc.); a leak of natural gas; etc.
15. Only put the handset of your telephone next to your ear when it is in normal talk mode.
16. The power adapters are intended to be correctly oriented in a vertical or floor mount position. The prongs are not designed to hold the plug in place if it is plugged into a ceiling, under-the-table or cabinet outlet.

SAVE THESE INSTRUCTIONS

Appendix

Precautions for users of implanted cardiac pacemakers

Cardiac pacemakers (applies only to digital cordless telephones):

Wireless Technology Research, LLC (WTR), an independent research entity, led a multidisciplinary evaluation of the interference between portable wireless telephones and implanted cardiac pacemakers. Supported by the U.S. Food and Drug Administration, WTR recommends to physicians that:

Pacemaker patients



- Should keep wireless telephones at least six inches from the pacemaker.
- Should NOT place wireless telephones directly over the pacemaker, such as in a breast pocket, when it is turned ON.
- Should use the wireless telephone at the ear opposite the pacemaker.

WTR's evaluation did not identify any risk to bystanders with pacemakers from other persons using wireless telephones.

Note: The CareLine™ transmitter is a wireless telephone, and it should not be used in the pendant form (hanging from a necklace over the heart) by persons wearing pacemakers. Pacemaker patients should use the CareLine™ product in belt-clip form only.

Operating range

This cordless telephone operates with the maximum power allowed by the Federal Communications Commission (FCC). Even so, this handset/pendant and telephone base can communicate over only a certain distance - which can vary with the locations of the telephone base and handset, the weather, and the layout of your home or office.

When the handset is out of range, the handset displays **Out of range OR Base no power**. If there is a call while the handset is out of range, it may not ring, or if it does ring, the call may not connect well when you press . Move closer to the telephone base, then press  to answer the call.

If the handset moves out of range during a telephone conversation, there may be interference. To improve reception, move closer to the telephone base.

ECO mode

This power conserving technology reduces power consumption for optimal battery performance. The ECO mode activates automatically whenever the handset is synchronized with the telephone base.

Appendix

Energy-saving charging mode

When this mode is activated, all telephone functions, except handset battery charging, will be disabled.

To activate the energy-saving charging mode:

1. Unplug the telephone base power adapter from the power outlet. Make sure all handsets are plugged with charged batteries.
2. While you press and hold **FIND HS**, plug the telephone base power adapter back to the power outlet.
3. After about 20 seconds, when the **IN USE** light starts flashing, release **FIND HS** and then press it again within 2 seconds.

 When the phone successfully enters the energy-saving mode, the **IN USE** light turns off and all handsets display **To register HS, see manual**.

When the phone fails to enter this mode, repeat Step 1 through Step 3 above.

Note: The telephone base will be powered up as normal if you fail to press **FIND HS** within 2 seconds in Step 3.

To deactivate the energy-saving charging mode:

1. Unplug the telephone base adapter from the power outlet, then plug it back in. Then the telephone base is powered up as normal.
2. Register your handset and pendant back to the telephone base. See pages 15 through 17 for registration instructions.

Maintenance

Taking care of your telephone

Your telephone contains sophisticated electronic parts, so it must be treated with care.

Avoid rough treatment

Place the handset down gently. Save the original packing materials to protect your telephone if you ever need to ship it.

Avoid water

Your telephone can be damaged if it gets wet. Do not use the handset outdoors in the rain, or handle it with wet hands. Do not install the telephone base near a sink, bathtub or shower.

Electrical storms

Electrical storms can sometimes cause power surges harmful to electronic equipment. For your own safety, take caution when using electrical appliances during storms.

Appendix

Maintenance

Cleaning your telephone

Your telephone has a durable plastic casing that should retain its luster for many years. Clean it only with a soft cloth slightly dampened with water or mild soap. Do not use excess water or cleaning solvents of any kind.

Remember that electrical appliances can cause serious injury if used when you are wet or standing in water. If the telephone base should fall into water, **DO NOT RETRIEVE IT UNTIL YOU UNPLUG THE POWER CORD AND TELEPHONE LINE CORD FROM THE WALL.** Then remove the telephone by the unplugged cords.

About cordless telephones

- **Privacy:** The same features that make a cordless telephone convenient create some limitations. Telephone calls are transmitted between the telephone base and the cordless handset by radio waves, so there is a possibility that the cordless telephone conversations could be intercepted by radio receiving equipment within range of the cordless handset. For this reason, you should not think of cordless telephone conversations as being as private as those on corded telephones.
- **Electrical power:** The telephone base of this cordless telephone must be connected to a working electrical outlet. The electrical outlet should not be controlled by a wall switch. Calls cannot be made from the cordless handset if the telephone base is unplugged, switched off or if the electrical power is interrupted.
- **Potential TV interference:** Some cordless telephones operate at frequencies that may cause interference to televisions and VCRs. To minimize or prevent such interference, do not place the telephone base of the cordless telephone near or on top of a TV or VCR. If interference is experienced, moving the cordless telephone farther away from the TV or VCR often reduces or eliminates the interference.
- **Rechargeable batteries:** Exercise care in handling batteries in order not to create a short circuit with conducting material such as rings, bracelets and keys. The battery or conductor may overheat and cause harm. Observe proper polarity between the battery and the battery charger.
- **Nickel-metal hydride rechargeable batteries:** Dispose of these batteries in a safe manner. Do not burn or puncture the battery. Like other batteries of this type, if burned or punctured, they could release caustic material which could cause injury.

Appendix

The RBRC® seal



The RBRC® seal on the nickel-metal hydride battery indicates that VTech Communications, Inc. is voluntarily participating in an industry program to collect and recycle these batteries at the end of their useful lives, when taken out of service within the United States and Canada.

The RBRC® program provides a convenient alternative to placing used nickel-metal hydride batteries into the trash or municipal waste, which may be illegal in your area.

VTech's participation in RBRC® makes it easy for you to drop off the spent battery at local retailers participating in the RBRC® program or at authorized VTech product service centers. Please call **1 (800) 8 BATTERY™** for information on Ni-MH battery recycling and disposal bans/restrictions in your area. VTech's involvement in this program is part of its commitment to protecting our environment and conserving natural resources.

RBRC® is a registered trademark of Rechargeable Battery Recycling Corporation.



The RBRC® seal on the lithium-ion battery indicates that VTech Communications, Inc. is voluntarily participating in an industry program to collect and recycle these batteries at the end of their useful lives, when taken out of service within the United States and Canada.

The RBRC® program provides a convenient alternative to placing used lithium-ion batteries into the trash or municipal waste, which may be illegal in your area.

VTech's participation in RBRC® makes it easy for you to drop off the spent battery at local retailers participating in the RBRC® program or at authorized VTech product service centers. Please call **1 (800) 8 BATTERY™** for information on Li-ion battery recycling and disposal bans/restrictions in your area. VTech's involvement in this program is part of its commitment to protecting our environment and conserving natural resources.

RBRC® is a registered trademark of Rechargeable Battery Recycling Corporation.

Appendix

Limited warranty

What does this limited warranty cover?

The manufacturer of this VTech Product warrants to the holder of a valid proof of purchase (“Consumer” or “you”) that the Product and all accessories provided in the sales package (“Product”) are free from defects in material and workmanship, pursuant to the following terms and conditions, when installed and used normally and in accordance with the Product operating instructions. This limited warranty extends only to the Consumer for Products purchased and used in the United States of America and Canada.

What will VTech do if the Product is not free from defects in materials and workmanship during the limited warranty period (“Materially Defective Product”)?

During the limited warranty period, VTech’s authorized service representative will repair or replace at VTech’s option, without charge, a Materially Defective Product. If we repair the Product, we may use new or refurbished replacement parts. If we choose to replace the Product, we may replace it with a new or refurbished Product of the same or similar design. We will retain defective parts, modules, or equipment. Repair or replacement of the Product, at VTech’s option, is your exclusive remedy. VTech will return the repaired or replacement Products to you in working condition. You should expect the repair or replacement to take approximately 30 days.

How long is the limited warranty period?

The limited warranty period for the Product extends for ONE (1) YEAR from the date of purchase. If VTech repairs or replaces a Materially Defective Product under the terms of this limited warranty, this limited warranty also applies to repaired or replacement Product for a period of either (a) 90 days from the date the repaired or replacement Product is shipped to you or (b) the time remaining on the original one-year warranty; whichever is longer.

What is not covered by this limited warranty?

This limited warranty does not cover:

1. Product that has been subjected to misuse, accident, shipping or other physical damage, improper installation, abnormal operation or handling, neglect, inundation, fire, water or other liquid intrusion; or
2. Product that has been damaged due to repair, alteration or modification by anyone other than an authorized service representative of VTech; or
3. Product to the extent that the problem experienced is caused by signal conditions, network reliability, or cable or antenna systems; or
4. Product to the extent that the problem is caused by use with non-VTech accessories; or
5. Product whose warranty/quality stickers, product serial number plates or electronic serial numbers have been removed, altered or rendered illegible; or
6. Product purchased, used, serviced, or shipped for repair from outside the United States of America or Canada, or used for commercial or institutional purposes (including but not limited to Products used for rental purposes); or
7. Product returned without a valid proof of purchase (see item 2 on the next page); or
8. Charges for installation or set up, adjustment of customer controls, and installation or repair of systems outside the unit.

Appendix

Limited warranty

How do you get warranty service?

To obtain warranty in the United States of America, please visit our website at www.vtechphones.com or call **1 (800) 595-9511**. In Canada, go to www.vtechcanada.com or dial **1 (800) 267-7377**.

NOTE: Before calling for service, please review the user's manual - a check of the Product's controls and features may save you a service call.

Except as provided by applicable law, you assume the risk of loss or damage during transit and transportation and are responsible for delivery or handling charges incurred in the transport of the Product(s) to the service location. VTech will return repaired or replaced Product under this limited warranty. Transportation, delivery or handling charges are prepaid. VTech assumes no risk for damage or loss of the Product in transit. If the Product failure is not covered by this limited warranty, or proof of purchase does not meet the terms of this limited warranty, VTech will notify you and will request that you authorize the cost of repair prior to any further repair activity. You must pay for the cost of repair and return shipping costs for the repair of Products that are not covered by this limited warranty.

What must you return with the Product to get warranty service?

1. Return the entire original package and contents including the Product to the VTech service location along with a description of the malfunction or difficulty; and
2. Include a "valid proof of purchase" (sales receipt) identifying the Product purchased (Product model) and the date of purchase or receipt; and
3. Provide your name, complete and correct mailing address, and telephone number.

Other limitations

This warranty is the complete and exclusive agreement between you and VTech. It supersedes all other written or oral communications related to this Product. VTech provides no other warranties for this Product. The warranty exclusively describes all of VTech's responsibilities regarding the Product. There are no other express warranties. No one is authorized to make modifications to this limited warranty and you should not rely on any such modification.

State/Provincial Law Rights: This warranty gives you specific legal rights, and you may also have other rights, which vary from state to state or province to province.

Limitations: Implied warranties, including those of fitness for a particular purpose and merchantability (an unwritten warranty that the Product is fit for ordinary use) are limited to one year from the date of purchase. Some states/provinces do not allow limitations on how long an implied warranty lasts, so the above limitation may not apply to you. In no event shall VTech be liable for any indirect, special, incidental, consequential, or similar damages (including, but not limited to lost profits or revenue, inability to use the Product or other associated equipment, the cost of substitute equipment, and claims by third parties) resulting from the use of this Product. Some states/provinces do not allow the exclusion or limitation of incidental or consequential damages, so the above limitation or exclusion may not apply to you.

Please retain your original sales receipt as proof of purchase.

Appendix

FCC, ACTA and IC regulations

FCC Part 15

This equipment has been tested and found to comply with the requirements for a Class B digital device under Part 15 of the Federal Communications Commission (FCC) rules. These requirements are intended to provide reasonable protection against harmful interference in a residential installation. This equipment generates, uses and can radiate radio frequency energy and, if not installed and used in accordance with the instructions, may cause harmful interference to radio communications. However, there is no guarantee that interference will not occur in a particular installation. If this equipment does cause harmful interference to radio or television reception, which can be determined by turning the equipment off and on, the user is encouraged to try to correct the interference by one or more of the following measures:

- Reorient or relocate the receiving antenna.
- Increase the separation between the equipment and receiver.
- Connect the equipment into an outlet on a circuit different from that to which the receiver is connected.
- Consult the dealer or an experienced radio/TV technician for help.

Changes or modifications to this equipment not expressly approved by the party responsible for compliance could void the user's authority to operate the equipment.

This device complies with Part 15 of the FCC rules. Operation is subject to the following two conditions: (1) this device may not cause harmful interference, and (2) this device must accept any interference received, including interference that may cause undesired operation. Privacy of communications may not be ensured when using this telephone.

To ensure safety of users, the FCC has established criteria for the amount of radio frequency energy that can be safely absorbed by a user or bystander according to the intended usage of the product. This product has been tested and found to comply with the FCC criteria. The handset may be safely held against the ear of the user.

Caution: To maintain the compliance with the FCC's RF exposure guideline, the telephone base shall be installed and used such that parts of the user's body other than the hands are maintained at a distance of approximately 20 cm (8 inches) or more.

This Class B digital apparatus complies with Canadian ICES-003.

For body worn operation, this pendant has been tested and meets the FCC RF exposure guidelines when used with the Vtech accessories supplied or designated for this product. Use of other accessories may not ensure compliance with FCC RF exposure guidelines.

Appendix

FCC, ACTA and IC regulations

FCC Part 68 and ACTA

This equipment complies with Part 68 of the FCC rules and with technical requirements adopted by the Administrative Council for Terminal Attachments (ACTA). The label on the back or bottom of this equipment contains, among other things, a product identifier in the format US:AAAEQ##TXXXX. This identifier must be provided to your telephone service provider upon request.

The plug and jack used to connect this equipment to premises wiring and the telephone network must comply with applicable Part 68 rules and technical requirements adopted by ACTA. A compliant telephone cord and modular plug is provided with this product. It is designed to be connected to a compatible modular jack that is also compliant. An RJ11 jack should normally be used for connecting to a single line and an RJ14 jack for two lines. See the installation instructions in the user's manual.

The Ringer Equivalence Number (REN) is used to determine how many devices you may connect to your telephone line and still have them ring when you are called. The REN for this product is encoded as the 6th and 7th characters following the US: in the product identifier (e.g., if ## is 03, the REN is 0.3). In most, but not all areas, the sum of all RENs should be five (5.0) or less. For more information, contact your telephone service provider.

This equipment may not be used with Party Lines. If you have specially wired alarm dialing equipment connected to your telephone line, ensure the connection of this equipment does not disable your alarm equipment. If you have questions about what will disable alarm equipment, consult your telephone service provider or a qualified installer.

If this equipment is malfunctioning, it must be unplugged from the modular jack until the problem has been corrected. Repairs to this telephone equipment can only be made by the manufacturer or its authorized agents. For repair procedures, follow the instructions outlined under the **Limited warranty**.

If this equipment is causing harm to the telephone network, the telephone service provider may temporarily discontinue your telephone service. The telephone service provider is required to notify you before interrupting service. If advance notice is not practical, you will be notified as soon as possible. You will be given the opportunity to correct the problem and the telephone service provider is required to inform you of your right to file a complaint with the FCC. Your telephone service provider may make changes in its facilities, equipment, operation, or procedures that could affect the proper functioning of this product. The telephone service provider is required to notify you if such changes are planned.

If this product is equipped with a corded or cordless handset, it is hearing aid compatible.

If this product has memory dialing locations, you may choose to store emergency telephone numbers (e.g., police, fire, medical) in these locations. If you do store or test emergency numbers, please:

Remain on the line and briefly explain the reason for the call before hanging up.

Perform such activities in off-peak hours, such as early morning or late evening.

Appendix

FCC, ACTA and IC regulations

Industry Canada

Operation is subject to the following two conditions: (1) this device may not cause harmful interference, and (2) this device must accept any interference, including interference that may cause undesired operation.

The term "IC:" before the certification/registration number only signifies that the Industry Canada technical specifications were met.

The Ringer Equivalence Number (REN) for this terminal equipment is 1.0. The REN is an indication of the maximum number of devices allowed to be connected to a telephone interface. The termination on an interface may consist of any combination of devices subject only to the requirement that the sum of the RENs of all the devices does not exceed five.

This product meets the applicable Industry Canada technical specifications.

Appendix

Technical specifications

Frequency control	Crystal controlled PLL synthesizer
Transmit frequency	Telephone base: 1921.536-1928.448 MHz Handset: 1921.536-1928.448 MHz Pendant: 1921.536-1928.448 MHz
Channels	5
Nominal effective range	Maximum power allowed by FCC and IC. Actual operating range may vary according to environmental conditions at the time of use.
Power requirements	Telephone base: 6V DC @ 400mA Handset charger: 6V AC @ 300mA Handset battery: 2.4V Ni-MH Pendant charger: 6V DC @ 400mA Pendant battery: 3.7V Li-ion
Memory	Phonebook: 50 memory locations; up to 30 digits and 15 characters Caller ID log: 50 memory locations; up to 24 digits and 15 characters

Index

A

- Add a handset 15
- Add a pendant 16
- Add a photo 31
- Add a reminder 92-95
- Announcement 99-101
- Answer a call 51
- Answering system and voicemail 109
- Answering system operation 109–118
- Answering system settings 98–108
- Answer on/off 102-103
- Audio Assist 53

B

- Battery 2, 3, 7, 8, 129, 130

C

- Call intercept 112
- Call screening 104, 111
- Caller ID 36, 44, 84–91
- Chain dialing 59
- Check voicemail 58
- Clear voicemail indicators 42
- Clock 35

D

- Date and time 35
- Delete a phonebook entry 79
- Delete a photo speed dial entry 83
- Delete caller ID log entries 91
- Delete messages 113, 114, 115
- Deregister all devices 18
- Dial a phonebook entry 77
- Dial mode 46, 57

- Dialing options 88
- Display screen messages 91, 122–125

E

- ECO mode 143
- Edit a phonebook entry 78
- Edit a photo speed dial entry 82
- End a call 51
- Equalizer 52

F

- Find handset 62

H

- Handset battery charging 7
- Handset battery installation 3
- Handset charger installation 4
- Handset icons 128
- Handset layout 24–26
- Handset lights 126
- Handset locator 62
- Happy message 49
- Home area code 45

I

- Icons 128
- Intercom 64–72

J

- Join a call 63

K

- Key tone 43

L

- LCD language 38
- Lights 126, 127
- Limited warranty 147–148

Index

M

Maintenance 144
Make a call 50
Memo 116
Menu 32
Message alert tone 107, 112
Message capacity 110
Message playback 113–114
Message recording time 108
Missed call indicator 86
Mute 54

N

Number of rings 105

O

Operating range 143
Operation 50-62, 109-118

P

Pendant attachment 6
Pendant battery charging 8
Pendant charger installation 5
Pendant layout 23
Phonebook 73–79
Photo speed dial 27–31, 80-83
Play messages 113–114

Q

Quiet mode 47

R

Record an announcement 99
Redial 56-57
Registration 15-17
Reminder 92–97
Remote access 106, 117-118
Rename 43

Review phonebook 76
Review reminders 96
Review the caller ID log 87
Ringer silencing 55
Ringer tone 34
Ringer volume 33

S

Save a caller ID log entry 90
Screen messages 91, 122-125
Set date and time 35
Settings 27-49, 98-108
Share a call 63
Speakerphone 51
Speed dial 27–31, 80–83

T

Tabletop 9-12
Talking digit 39
Technical specifications 152
Telephone base icons 128
Telephone base installation 1
Telephone base layout 19–22
Telephone base lights 126
Tone dialing 46, 57
Transfer a call 60-61, 69-72
Troubleshooting 131–140

V

Voice Announce caller ID 36
Voice command 48, 119–121
Voicemail 14, 40-41, 58, 109, 110
Volume 33, 54, 111, 113, 114

W

Wall mount 9–12
Warranty 147–148

VTECH TELECOMMUNICATIONS LTD.
A member of THE VTECH GROUP OF COMPANIES.
VTech is the registered trademark of VTech Holdings Limited.
Copyright © 2013 for VTECH TELECOMMUNICATIONS LTD.
All rights reserved. Version 3 08/13.

91-007054-010-100

vtech[®]